



# ENVIRONMENTAL GUIDANCE MANUAL

Committed to Environmental  
Sustainability



*Photo by Jake Reed: Newfane Substation and Newfane Tap line*

**August 2023**

## Revision Sheet for the VELCO Environmental Guidance Manual (VEGM)

This August 2023 version of the VEGM underwent a major rewrite and changes were not tracked.  
Future revisions of VEGM will be tracked in the following table:

Rev. No.	Date	Description

# CONTENTS

- PURPOSE AND BACKGROUND ..... 1
  - Purpose ..... 1
  - Background ..... 1
- CONTACT INFORMATION ..... 2
- ACRONYMS ..... 2
- TERMS AND DEFINITIONS ..... 3
- ENVIRONMENTAL COMPLIANCE POLICY & APPROACH ..... 7
  - VELCO’s Environmental Compliance Policy ..... 8
  - Training ..... 8
  - Protected Resource Area Reviews ..... 8
  - Workflow ..... 9
  - Roles and Responsibilities ..... 9
    - Environmental Team/Inspectors ..... 9
    - Contractors/Field & Access Coordinators ..... 10
    - All Project Personnel ..... 11
  - STAR Protocol ..... 11
  - Tailboard ..... 11
  - Compliance Oversight ..... 12
- GENERAL WORK PRACTICES & PROCEDURES ..... 12
  - Pre-Work Scoping ..... 12
  - Flagging ..... 13
  - Access Review ..... 13
    - Access Selection Procedure ..... 14
    - Changes to Access Routes ..... 14
  - Look Ahead Procedure ..... 14
  - Change Review Procedure ..... 15
  - Incident Reporting ..... 16
    - Incident Reporting Procedure ..... 16
  - Unanticipated Resource Discovery Response Procedure ..... 17
- WASTE MANAGEMENT ..... 18
  - General Housekeeping ..... 18
  - Architectural Waste ..... 19
  - Asbestos ..... 19
  - Concrete Washout ..... 19
  - E-Waste ..... 19
  - Lead-Based Paint ..... 20
  - PCBs ..... 20
  - Soils ..... 20
  - Substation & Utility Line Materials ..... 21
  - Treated Wood (Pentachlorophenol) ..... 21

Universal Recycling & Composting.....	22
Universal Waste .....	22
Used & Waste Oil.....	22
<b>HAZARDOUS MATERIALS &amp; SPILL RESPONSE.....</b>	<b>22</b>
Spill Prevention .....	23
Equipment Check.....	23
Oil and Hazardous Material Storage.....	23
Maintenance of Equipment on the ROW .....	24
Refueling.....	24
Spill Kits.....	25
Tailboard .....	25
Spill Response & Cleanup Procedure.....	26
Spill Response Actions .....	26
Required Notifications .....	26
Spill Reporting .....	27
Cleanup & Remediation .....	27
<b>EROSION PREVENTION &amp; SEDIMENT CONTROL (EPSC).....</b>	<b>28</b>
Projects with Stormwater Permits .....	29
EPSC Measures.....	29
Grading Activities .....	31
Construction Entrances.....	31
Soil Handling Activities.....	32
Soil Segregation.....	32
Excess Soil.....	32
Site Inspections.....	32
Active Construction .....	32
Inactive Construction Sites.....	32
Post Construction & Final Inspection .....	32
Dewatering Procedure .....	33
Dewatering Structure Placement .....	33
Restoration.....	34
Disturbed Areas .....	34
Seed Mixes.....	35
Improved Areas.....	36
Construction Mats .....	36
Staging Areas and Construction Support Areas .....	36
<b>WETLANDS .....</b>	<b>36</b>
Flagging/Signage .....	37
Fueling.....	37
Dry/Frozen Conditions .....	37
Construction Matting Requirements.....	38
Soil Handling .....	40
Dewatering .....	40
Permanent Fill Roads.....	40
Stabilization and Restoration .....	40
Emergency Activities.....	41

STREAMS .....	41
Flagging.....	41
Stream Assessments .....	42
Aquatic Organism Passage.....	43
Riparian Buffers .....	44
Flood Hazard Areas and River Corridors.....	44
Stream Crossing Structures .....	45
Mat Bridges .....	45
Culverts .....	46
Stabilized Fords .....	47
Brush Matting .....	47
Prefabricated Bridges.....	47
Ice Bridges .....	47
Permanent Bridges .....	48
Stream Erosion Prevention and Sediment Control .....	49
Stabilization .....	49
Water Source Control.....	49
Stream Crossing EPSC BMPs .....	50
Restoration .....	50
RARE, THREATENED & ENDANGERED SPECIES .....	51
T&E BMPs.....	51
Flagging/Signage .....	52
Work In RTE Polygons .....	52
NON-NATIVE INVASIVE SPECIES (NNIS) MONITORING & CONTROL.....	53
Avoidance and Minimization Measures .....	54
OTHER SENSITIVE RESOURCES .....	55
Natural Communities and Rare and Irreplaceable Natural Areas (RINA) .....	55
Deer Wintering Areas.....	55
Black Bear Habitat .....	56
Osprey.....	56
Grassland Birds.....	58
Prime Agricultural Soils .....	58
Avoidance and Minimization .....	59
Working in PAS .....	59
Drinking Water Protection .....	60
ARCHAEOLOGY .....	60
Archaeological BMPs .....	61
Data Management.....	61
Site Identification .....	61
Site Avoidance .....	62
Site Protection and Minimize Risk of Impacts.....	62
Emergency Response BMPs .....	64
Unanticipated Discovery of Cultural Resources.....	64
SUMMARY.....	65

# ATTACHMENTS

Change Review Form .....	66
Environmental Incident Report .....	67
Pole Waiver Form and Environmental Fact Sheet.....	68
Docket 8310 Appendix 1 .....	73
Details: EPSC	
Barrier Fence .....	EPSC-1
Stabilized Construction Entrance.....	EPSC-2
Silt Fence .....	EPSC-3
Reinforced Silt Fence.....	EPSC-4
Silt Fence - One Slope.....	EPSC-5
Silt Fence - Perimeter .....	EPSC-6
Silt Fence - Two Slopes .....	EPSC-7
Filter Sock .....	EPSC-8
Filter Sock Connection & Stack .....	EPSC-9
Erosion Control Berm.....	EPSC-10
Rolled Erosion Control Product .....	EPSC-11
Rolled Erosion Control Product Channel.....	EPSC-12
Mulch Anchoring .....	EPSC-13
Check Dam .....	EPSC-14
Stone Inlet Protection.....	EPSC-15
Soil Stockpile .....	EPSC-16
Concrete Washout .....	EPSC-17
Dewatering Basin.....	EPSC-18
Reinforced Dewatering Basin .....	EPSC-19
Filter Bag Dewatering .....	EPSC-20
Details: Wetland/Stream Crossings	
Unimproved Ford Crossing.....	CRS-1
Improved Ford Crossing .....	CRS-2
Open Bottom Pipe Arch Culvert.....	CRS-3
Embedded Culvert for Stream Crossing.....	CRS-4
Non-Stream Culvert .....	CRS-5
Timber Mat Bridge .....	CRS-6
Alt. Timber Mat Bridge .....	CRS-7
Wetland Timber Matting.....	CRS-8
Temporary Culvert .....	CRS-9
Alt. Temporary Culvert.....	CRS-10
Wetland Cross-Culvert.....	CRS-11
Details: Stormwater	
Treatment Swale.....	SW-1
Ditch Turn-Out .....	SW-2
Water Diversion Channel.....	SW-3
Water Bar Detail.....	SW-4
Stone Discharge Apron.....	SW-5

Details: Access

Access Road .....	AR-1
Temp Brush Matting.....	AR-2
Temp Woodchip Road .....	AR-3
Temp Access Road.....	AR-4

# PURPOSE AND BACKGROUND

## PURPOSE

The purpose of the Vermont Electric Power Company, Inc. (VELCO) Environmental Guidance Manual (VEGM) is to provide best management practices to VELCO's employees and contractors so they can effectively avoid and/or minimize impacts to Protected Resource Areas while working on VELCO properties and rights-of-way. The practices and procedures explained in this document and associated attachments apply to all personnel accessing VELCO property, rights-of-way (ROWs), and infrastructure associated with VELCO-directed activities, such as maintenance, inspections, and/or construction purposes.

VELCO constructs, operates, and maintains Vermont's electric transmission grid and associated communication infrastructure. Physical access onto company owned property, ROWs, and/or private property may be necessary to conduct work on VELCO's assets. Due to the extent and scope of the system assets VELCO manages, Protected Resource Areas, such as wetlands, streams, and archeological sites, may be encountered while performing such work.

This document shall be utilized in conjunction with VELCO's Safety Manual, Transmission Vegetation Management Plan (TVMP), and other relevant VELCO policies, plans, and procedures.

## BACKGROUND

Headquartered in Rutland, Vermont, VELCO employees strive to provide Vermont's utilities and their customers/owners a safe, reliable, and resilient high-voltage electric transmission system, a strong unified voice on regional energy issues, and continued access to safe, reliable, and cost-effective electricity.

VELCO was formed in 1956 when Vermont's local electric utilities joined together to establish the nation's first statewide, "transmission only" company in order to create and maintain an interconnected electric transmission grid capable of sharing access to clean hydro power. VELCO currently manages a system that includes:

- 740 miles of transmission lines
- 14,000 acres of rights-of-way
- 55 substations, switching stations and terminal facilities
- Equipment that enables interconnected operations with Hydro-Québec
- Fiber optic communication networks that monitor and control the electric system and serve as a key link for Vermonters' high-speed data internet access
- 52-mile 450 kV direct current line through the Northeast Kingdom owned by Vermont Electric Transmission Company (VETCO)
- Approximately 55 radio sites



## CONTACT INFORMATION

The VELCO Environmental Guidance Manual (VEGM) is owned and maintained by the VELCO Environmental Team. If there are any questions, comments, or concerns regarding the content herein, please contact the VELCO Environmental Team:

**Timothy Follensbee II**, *VELCO Environmental Manager*

Office: (802) 770-6423

Email: [tfollensbee@velco.com](mailto:tfollensbee@velco.com)

Address: 366 Pinnacle Ridge Road, Rutland, VT 05701

## ACRONYMS

AAFM	Vermont Agency of Agriculture, Food & Markets
ANR	Vermont Agency of Natural Resources (also see VTANR)
BMP/s	Best Management Practice/s
DHP	Vermont Division for Historic Preservation
EI	Environmental Inspector
EPA	Environmental Protection Agency
EPSC	Erosion Prevention and Sediment Control
NRCS	Natural Resources Conservation Service
NRHP	National Register of Historic Places
OHM	Oil and Hazardous Material
O&M	Operations & Maintenance
OSPC	On-Site Plan Coordinator
PAS	Prime Agricultural Soil
PIC	Person In Charge
PPE	Personal Protective Equipment
PUC	Public Utility Commission
RINA	Rare and Irreplaceable Natural Areas
RTE	Rare, Threatened or Endangered Species
ROW	Right-of-Way
SHPO	State Historic Preservation Office
SPCC	Spill Prevention, Control, and Countermeasure
SOW	Scope of Work
T&E	Threatened & Endangered
TVMP	VELCO's Transmission Vegetation Management Plan
VELCO	Vermont Electric Power Company/VT Transco LLC
VFWD	Vermont Fish and Wildlife
VTANR	Vermont Agency of Natural Resources (also see ANR)
VTRANS	Vermont Agency of Transportation
USACE	U.S. Army Corps of Engineers
USFWS	U.S. Fish and Wildlife Service
VEGM	VELCO Environmental Guidance Manual (this document)

# **TERMS AND DEFINITIONS**

**Allowed Use:** Specifically in the Vermont Wetland Rules, is an activity that is deemed allowable or acceptable in a Class I or Class II wetland and its buffer zone without a permit, provided that the configuration of the wetland's outlet or the flow of water into or out of the wetland is not altered and that no draining, dredging, filling, or grading occurs except as may be provided for by certain activities (see the Vermont Wetland Rules [2023] Section 6 for those specific activities).

**Approved Access Route:** A designated, approved travelway utilized to transport personnel, equipment, and/or materials from a public roadway to a work site. Approved Access Routes will be shown on Project Plans and may be marked with flagging and/or signs in the field. Roads and paths not identified on Project Plans should not be used until appropriate environmental/archeological review is performed and approval for use is issued by the VELCO Environmental Team.

**Archaeological Site:** A defined area exhibiting evidence of past human activity or occupation as indicated by the presence of artifacts, archaeological features, etc. either above or below ground. Similar to Historic Site.

**Architectural Waste:** Certain types of waste (e.g., drywall, metal, asphalt shingles, clean wood, plywood, and oriented strand board) that is recyclable per Vermont regulations and should not be disposed of at landfills.

**Best Management Practices (BMPs):** Specific actions implemented in order to avoid or mitigate impacts to Sensitive Resources.

**Clearing:** The cutting, windrowing, and/or removal of vegetation by hand or mechanical means.

**Common Backfill:** Unless outlined in project-specific specifications, common backfill is defined as previously excavated soil deemed suitable for backfill material.

**Construction Project/s:** All field work that is not classified as Maintenance.

**Construction Mats:** A temporary, portable platform or a structural roadway over unstable ground used to support equipment. Also referred to as "swamp mats" or "timber mats" these typically consist of wood or composite material and are designed to reduce the ground pressure of heavy equipment specifically in areas with Sensitive Resources such as wetlands and archaeological areas or wherever soil protection measures are necessary (agricultural fields).

**Contractor/s:** Work crew/s hired by VELCO to perform construction or maintenance activities on VELCO owned or leased properties and easements/rights-of-way.

**Dry/Frozen Evaluation:** An evaluation performed by VELCO Environmental or its designee to identify Work Areas that may become dry or frozen enough to work in without utilizing temporary fill or construction mats and without adversely affecting the environment.

**Environmental Compliance Report:** A document prepared by VELCO Environmental, its consultants, or the Environmental Compliance Inspector detailing the status of environmentally-related project activities and recommendations to avoid and/or mitigate impacts to sensitive resources. Applicable content includes, but is not limited to, regulatory permit compliance, erosion prevention and sediment control measures, impact avoidance/mitigation measures, and the adherence to VELCO's policies and procedures.

**Environmental Inspector (EI):** An Inspector that monitors Work and provides guidance to the field crews on environmental concerns along with other BMPs to ensure regulatory compliance. The Environmental Inspector is also called the Environmental Compliance Inspector or Compliance Inspector.

**Environmental Team:** The employees from the VELCO Environmental Management Department responsible for all phases of environmental planning, assessment, permitting and regulatory compliance associated with VELCO projects including, but not limited to, the construction and maintenance of electric transmission lines and substations, facilities, fiber optic lines, and radio sites. Also referred to as VELCO Environmental or Environmental.

**Ephemeral Stream:** A stream that flows only in direct response to precipitation and whose channel is at all times above the water table.

**Erosion Prevention and Sediment Control (EPSC) Specialist:** Individual responsible for ensuring the proper deployment, maintenance, and removal of erosion control measures, and conducting routine inspections and associated reporting. This position is generally required for certain projects with high-risk Construction Stormwater permits and this role is many times filled by the Environmental Inspector.

**Erosion Prevention and Sediment Control (EPSC) Plan:** A project-specific document summarizing erosion and sediment control measures for a Construction Project.

**Field/Access Coordinator:** The VELCO team representative that manages and oversees specific Work and associated Work Crews to administer VELCO's policies, plans, and procedures.

**Flood Hazard Area:** The land in the floodplain within a community subject to a one percent or greater chance of flooding in any given year. The term has the same meaning as "area of special flood hazard" under 44 C.F.R. § 59.1.

**Frozen Evaluation:** See Dry/Frozen Evaluation above.

**Hazardous Waste:** Waste with properties that make it dangerous or capable of having a harmful effect on human health or the environment. Hazardous characteristics include ignitability, corrosivity, reactivity, and toxicity.

**Historic Site:** Any site, structure, district or archaeological landmark that has been officially included in the Vermont State Register of Historic Places and/or the National Register of Historic Places.

**Intermittent Stream:** Any nonpermanent flowing drainage feature having a definable channel and evidence of scour or deposition. This includes what are sometimes referred to as ephemeral streams if they meet these two criteria.

**Maintenance:** Work activity involving the inspection, reconnaissance, evaluation, repair, and in-kind replacement (without substantial enlargement) of existing infrastructure (e.g., transmission structures, substations, fiber grid, and radio sites).

**Natural Community:** An interacting assemblage of plants and animals, their physical environment, and the natural processes that affect them.

**Necessary Wildlife Habitat:** Concentrated habitat that is identifiable and is demonstrated as being decisive to the survival of a species of wildlife at any period in its life including breeding and migratory periods.

**Oil and Hazardous Material (OHM):** Means any waste, pollutant, hazardous substance, toxic substance, hazardous waste, special waste, industrial substance or waste, petroleum or petroleum-derived substance or waste, or asbestos-containing substance. They have the potential to pose a reasonable risk to health, property, or the environment. Common OHM encountered during Work include gasoline, hydraulic oil, and diesel fuel.

**On-Site Plan Coordinator (OSPC):** Individual responsible for ensuring the proper deployment of erosion control measures, conducting routine inspections, and reporting. Other responsibilities include site plan updates, edits, documenting any modifications to new areas of soil disturbance, equipment access routes, and alterations to proposed erosion control measures.

**Perennial Stream:** One which flows continuously.

**Person in Charge (PIC):** The VELCO individual responsible for the Tailboard safety briefing; informing VELCO operations/security of Work Crew size, scope, and location information; providing awareness of job activities for visitors; and identifying work tasks for the job site. The PIC may also hold the clearance/tag for electrical work.

**Pre-Construction Look Ahead:** A site inspection and work scope review completed before any work is performed. The purpose of the review is to identify and discuss specific permit conditions and review special work practices, Project Plans, impact mitigation measures, restoration activities, etc. At a minimum, this inspection shall be performed by a group consisting of a member or representative of the VELCO Environmental Team, a Work Crew Supervisor, and a Field Coordinator. Also called the Look Ahead.

**Prime Agricultural Soil:** Important farmland soils map unit that the NRCS has identified and determined to have a rating of prime, statewide, or local importance. PAS are protected in the State of Vermont through its Land Use regulations (Act 250 and Section 248). Also referred to as Statewide Agricultural Soils and Prime Ag Soil.

**Project Plans:** Plans and drawings that form part of a permit or are based on a permit that depict regulated areas, Sensitive Resources and Approved Access Routes.

**Protected Resource Area/s:** A location that has been determined to contain environmentally sensitive features, which may include, but is not limited to wetlands, rivers/streams, drinking water source protection areas, shorelines, RTE, RINA, archaeological sites, and necessary wildlife habitat. Protected resources are also referred to as “sensitive resources” or “sensitive resource areas.”

**PUC / Vermont Public Utility Commission:** An independent, three-member, quasi-judicial commission that regulates the siting of electric and natural gas infrastructure and supervises the rates, quality of service, and overall financial management of Vermont's public utilities: electric, gas, energy efficiency, telecommunications, cable television (terms of service only, not rates), water, and large wastewater companies.

**Rare and Irreplaceable Natural Area (RINA):** Area of unique or rare habitat of special importance or significance. These areas are often wetlands containing populations of threatened or endangered species. Refer to Significant Natural Communities.

**Rare, Threatened, or Endangered Species (RTE):** Special plant and animal species which may be protected through the Section 248 process. Vermont RTE plants and animals are listed on the rare and uncommon species lists compiled by Vermont Fish and Wildlife Department (VFWD). Threatened and

endangered species are afforded additional protections at the state and federal level (see Threatened and Endangered Species).

**Right of Way (ROW):** A corridor through a property belonging to another where VELCO has legal rights to access, construct, operate, and/or maintain the electrical transmission system and associated equipment.

**Riparian Buffer Zone:** The width of land adjacent to lakes or streams between the top of the bank or top of slope or mean water level and the edge of other land uses. Riparian buffer zones are typically undisturbed areas, consisting of trees, shrubs, ground cover plants, duff layer, and naturally vegetated uneven ground surface, that protect the waterbody and the adjacent riparian corridor ecosystem from the impact of these land uses.

**River Corridor:** The land area adjacent to a river that is required to accommodate the dimensions, slope, planform, and buffer of the naturally stable channel and that is necessary for the natural maintenance or natural restoration of a dynamic equilibrium condition and for minimization of fluvial erosion hazards, as delineated by the Vermont Agency of Natural Resources in accordance with river corridor protection procedures (10 V.S.A. § 1422(12)).

**Scope of Work (SOW):** A description of the work activities, deliverables, and/or timeline that a contractor, vendor, or crew agree upon to execute the Work.

**Sensitive Resource/s:** A natural resource that is significantly more susceptible to negative impacts that may be caused by Work without proper protections in place. Examples of sensitive resources include wetlands, rivers/streams, drinking water source protection areas, shorelines, RTE, RINA, archaeological sites, and necessary wildlife habitat. Oftentimes work near or in these resources requires a permit issued by a state or federal regulatory agency. Also see Protected Resource Areas.

**Significant Natural Community:** A Natural Community that has been deemed significant by VFWD based on an assessment of community size, current ecological condition, and ecological condition of the landscape in which the community occurs.

**Stream/s:** A watercourse that flows water by gravity for at least a portion of the year, through a natural channel created from concentrated flow, containing a clearly identifiable streambed and banks, where the streambed is unvegetated due to regular inundation and the bank slopes confine normal flows of the active channel.

**Thalweg:** The longitudinal line connecting the deepest points of the stream where forces and flow velocity of the stream are the greatest.

**Threatened and Endangered Species (T&E):** Special plant and animal species which are protected by state and/or federal regulations.

**Top of Bank:** The point along the stream bank where an abrupt change in slope is evident and where the stream is generally able to overflow the banks and enter the adjacent floodplain during flows at or exceeding the average annual high water stage.

**Top of Slope:** A break in slopes adjacent to steep-banked streams that have little or no floodplain or a break in slope where the side slopes adjacent to an incised or deeply cut channel meet floodplains that have been abandoned or are undergoing abandonment.

**U.S. Army Corps of Engineers (USACE):** Federal agency that regulates wetland and waterway impacts such as the placement of fill and construction mats within wetlands. In addition, the USACE also regulates structures in, over, or under navigable waterways.

**Universal Wastes:** Low-risk hazardous wastes that are widely produced by households and many different types of businesses. Universal wastes include, but are not limited to, certain batteries, fluorescent lamps, mercury thermostats and other mercury-containing equipment, and aerosol cans.

**Used Oil:** Any oil that has been refined from crude oil or any synthetic oil that has been used and, as a result of that use, is contaminated by physical or chemical impurities. Examples include crankcase oils, transmission fluids, and hydraulic oils that have been used.

**Vermont Agency of Natural Resources (VTANR):** The state agency that is charged with oversight and management of Vermont's natural environment on behalf of the people of Vermont and is comprised of the Department of Environmental Conservation, Department of Fish and Wildlife, and Department of Forest, Parks and Recreation.

**Waste Oil:** Oil that can no longer perform its intended use and is unfit for recycling and/or has been contaminated with substances that may or may not be hazardous.

**Wetland/s:** Wetlands are areas that are inundated or saturated by surface or groundwater at a frequency and duration sufficient to support, and that under normal circumstances do support, a prevalence of vegetation typically adapted for life in saturated soil conditions.

**Wetland Buffer/s:** An area of upland adjacent to significant wetlands regulated by the State of Vermont, which serve to protect the wetland's function and values.

**Work:** Field work associated with a Construction Project or Maintenance.

**Work Area:** All areas where the Work is to be performed, including support locations. This includes access roads, staging areas, laydown areas, substations and all other areas where Work Crews may store, stage, park and/or operate equipment or vehicles for the purpose of executing the Work.

**Work Crew/s:** The workers, supervisors and managers executing and responsible for executing the Work. This includes VELCO employees, contractors, subcontractors, and consultants.

## **ENVIRONMENTAL COMPLIANCE POLICY & APPROACH**

VELCO uses a proactive approach to protecting environmental resources which begins in project or maintenance planning and is upheld through and after completion of work. VELCO utilizes the systems outlined in the following subsections to ensure company values are upheld and that all Work remains in compliance with applicable rules and regulations. VELCO has adopted a multi-layered approach to ensure environmental compliance that includes: training, resource reviews, pre-work planning and reviews, and environmental oversight and reporting.

## VELCO'S ENVIRONMENTAL COMPLIANCE POLICY

All VELCO employees and contractors have a duty to comply with all VELCO policies and procedures, regulatory requirements, and permit conditions, and to report any incidents of potential non-compliance to their supervisor and the VELCO Environmental Team.

### TRAINING

The proper training of VELCO employees and its contractors is an essential component of this layered approach to environmental compliance. Training aims to address the environmental compliance risks associated with the trainee's work task/s. Oftentimes, a more general overview of environmental rules and regulations is needed for contractors that frequent VELCO properties/ROWs in order to perform routine or miscellaneous maintenance or operational tasks.

All VELCO contractors, subcontractors, and employees with field responsibilities shall complete Environmental training prior to initiating work. Successful trainings are documented in the applicable database and, whenever possible, visualized with a custom VELCO Environmental hard hat sticker. Trainings are typically valid for two years. It is the responsibility of the individual/contractor to request refresher trainings. The Environmental Team currently maintains two different environmental compliance trainings with each tailored to the respective work task and/or field of work:

**General Environmental Sensitivity Training** provides a broad overview of environmental and archaeological rules, regulations, and associated compliance risks. This is the go-to training for most contractors.

**Advanced Environmental Training** is tailored for a specific project/Work and/or job duty. An example of Advanced Environmental Training is Environmental Inspector training which is provided to those inspecting, installing, or maintaining erosion prevention and sediment control measures and overseeing Work such as restoration activities, inspecting or installing wetland or waterway fills, completing work in or around RTE populations, or other work around sensitive resource areas. Another example of Advance Environmental Training would be training for contractors/subcontractors/employees performing construction activities which addresses project specific permits/conditions.

### PROTECTED RESOURCE AREA REVIEWS

A key component in VELCO's approach to environmental compliance is the resource review process. This consists of a detailed desktop and/or field analysis of the area/s where work is proposed and relies heavily on the use of existing data, geographic information systems (GIS) mapping, and an evaluation of applicable documentation regulatory or otherwise. If existing resource information is not available or adequate for the proposed Work, field evaluations by the VELCO Environmental Team or a qualified consultant may be necessary.

VELCO has developed a comprehensive natural and cultural resource database that serves as the primary tool for ensuring environmental compliance on its properties and ROWs easement lands. The VELCO Environmental Team's resource review toolbox consists of: ESRI software which houses and displays VELCO's comprehensive geodatabase of field-delineated Protected Resource areas (also referred to as Geonet or Environmental Geonet), Vermont Agency of Natural Resources (VTANR) Natural Resource Atlas, and Project-specific maps and/or plans. The database is updated regularly to provide the best available knowledge for all Work.



## WORKFLOW

VELCO utilizes a multi-layered approach to work planning including Pre-Work Scoping, natural resource assessments, permitting (if applicable), and the Look Ahead. Each of these steps is designed to plan better, more sustainable projects that have less impact on natural resources.

The Environmental Team is involved in large capital projects as the Scope of Work is developed and in smaller projects during the planning and design phase. This approach ensures that environmental considerations are in the forefront and potential areas of avoidance to protect sensitive resources can be identified before the design is underway and help evaluate design alternatives.

Pre-Work Scoping occurs in the planning phase. It includes, among other things (see [Pre-Work Scoping section](#) for full extent of process), environmental considerations which help the project team during the planning phase to fully consider and vet any avoidance or mitigation necessary for protected resources. The VELCO Environmental Team or a contractor on its behalf then performs a natural resource assessment of the entire project area including any areas supplementary to project work such as staging or laydown areas. This data is then presented in a report, and data is added to the VELCO-maintained geodatabase and any mapbooks produced for the project. Concurrently with natural resource reviews, VELCO Environmental begins any permitting and consultation necessary for the project. Permits and other conditions are then reflected in the design plans and/or contract documents. This document (VEGM) is also issued and must be adhered to by all those who perform work on behalf of VELCO. Work-specific permits and their conditions supersede this document. However, in the absence of permits, this guidance reflects how Work should be conducted.

As project work nears, VELCO Environmental staff along with members of the construction team perform the Look Ahead (see [Look Ahead Procedure section](#) for more info). Its purpose is to provide project construction personnel with the necessary environmental clearance to access and perform activities in the Work Areas, ensure effective communication, and define [roles and responsibilities](#).

The Environmental Team maintains an active presence throughout the entirety of the Work from planning, permitting, construction and restoration to ensure that all permits, conditions, rules and regulations, and guidance provided herein to protect resources are followed. After Work is completed, the Environmental Team or an appointed contractor, such as an Environmental Inspector, then performs any site inspections and mandated monitoring. The Environmental Team also meets internally on a regular basis to discuss lessons learned to better design projects, promote sustainability, and protect natural resources.

## ROLES AND RESPONSIBILITIES

### Environmental Team/Inspectors

The VELCO Environmental Team ensures VELCO's compliance with all applicable environmental permits, rules, and regulations for all VELCO work. Compliance begins during planning and is ongoing throughout the life of the project. The decision to proceed with a construction or maintenance activity from an environmental compliance perspective will be made by the Environmental Team. Project compliance is overseen by an Environmental Inspector, who may be a member of the Environmental Team or a contracted resource that reports to the Environmental Team.

The Environmental Inspector will monitor Work and provide guidance to the work crews regarding environmental concerns along with other BMPs to ensure regulatory compliance. The responsibilities of



the Environmental Inspector generally include (but are not limited to):

- Provide guidance during planning/Look Ahead phase of project to help minimize and/or avoid natural resource areas
- Provide Environmental Training/s to contractors and crews performing VELCO work
- Lead Tailboard discussions on resource areas before any project work begins in that area
- Install and maintain field flagging as needed for Protected Resource Areas (e.g., wetlands, RTE, access routes, archeological areas, etc.)(See [Flagging](#) section below for VELCO flagging standards)
- Oversee and assist the actions and reporting of the On-Site Plan Coordinator (OSPC), as required by the permit/s
- Ensure that all EPSC measures are installed properly and maintained throughout the duration of the work/project through to final restoration (see attached [EPSC details](#) for typical)
- Ensure all necessary field changes are properly documented, as required
- Conduct turbidity monitoring and generation of discharge reports, as required
- Oversee work on a consistent basis to ensure it is performed in accordance with this document and, when applicable, permit authorizations and project protection plans
- Assist the contractor or maintenance crew/s in the selection and implementation of the appropriate environmental protection measures in the absence of permits or project protection plans (e.g. work in wetlands under an Allowed Use)
- Perform routine inspections for environmental compliance reporting
- Inspect recently stabilized areas (temporary and/or permanent)
- Ensure work within wetland and waterways are completed in compliance with project permits and/or applicable regulations
- Ensure that all work within Protected Resource Areas is completed in compliance with project permits and/or applicable regulations
- Coordinate and oversee spill response activities and ensure appropriate cleanup and documentation (see [Spill Response & Clean Up Procedure](#))

The Environmental Team is responsible for reporting permit deviations, including potential or known compliance violations, to Legal Counsel and the appropriate regulatory agencies.

## **Contractors/Field & Access Coordinators**

Contractors/Field & Access Coordinators shall complete all work in accordance with permit requirements and/or applicable guidance/regulations and maintain regulatory compliance on their job sites. VELCO Environmental personnel will provide guidance and recommendations to Contractors, Field Coordinators, the OSPC, and Construction Supervisors to help maintain compliance.

Contractors/Field & Access Coordinators, in collaboration with the Environmental Team, are responsible for ensuring that all field crews are familiar with the permit conditions and requirements and have received necessary trainings when working around or in natural resource areas.

Contractors/Field & Access Coordinators shall recognize that field conditions can change on a daily or even hourly basis. As a result, the Environmental Team or Environmental Inspector may suspend activities in certain Work Areas based on changing field conditions (e.g., weather). Before suspending activities in a Work Area, the Environmental Team or Inspector will, if possible, consult with the Construction Manager and/or Field Coordinators, and the Contractors to ensure all available steps/options are explored prior to stopping work. It is incumbent on the Contractor/Field & Access Coordinators to stop work if field conditions may result in a possible non-compliance situation, such as a permit violation or failed BMPs.

## All Project Personnel

All project personnel shall utilize the STAR protocol (Stop, Think, Act, and Review) if they see any potential safety or environmental issues and immediately report the situation to the appropriate department (VELCO Safety or Environmental).

## STAR PROTOCOL



The STAR protocol stands for **Stop, Think, Act & Review**. This protocol is intended to be a short acronym that is easily remembered for quick and efficient implementation when conditions change compared to what was planned or anticipated. This protocol is specifically valuable as it relates to safety and environmental concerns and is a valuable preventive approach for many aspects of the Work. The STAR protocol is used to focus attention on the specific task by pausing to consider intended outcomes, the relevant environmental conditions/factors, and the multitude of internal and external factors that may influence the Work/task to be performed. By thinking about the intended action, understanding the expected outcome before acting, then

verifying the intended results after the action, you can systematically minimize safety and environmental risks. STAR is an expected standard of performance for personnel at all times during their daily work activities. An individual must be 100% sure that the action they are about to take is the correct one for the given circumstance.

## TAILBOARD

The Tailboard is tool VELCO uses to ensure safety and good communication with workers before a job begins. The form provides a systematic way for the Person in Charge (PIC) to outline any job hazards, special precautions, personal protective equipment (PPE) required, inspections necessary, and environmental considerations that pertain directly to the work being accomplished. The Tailboard and accompanying briefing are mandatory daily. See the VELCO Safety Manual for a complete review of Tailboard procedure.

VELCO Tailboard includes the following environmental criteria:

<b>I HAVE REVIEWED THE MAPS, PLANS, AND PERMITS FOR MY JOB SITE.</b>	<b>YES</b>	<b>NO</b>	<b>N/A</b>	<b>IF YES, PROCEED.</b>
	<input type="checkbox"/>	<input type="checkbox"/>	<input type="checkbox"/>	<b>IF NO, CONTACT VELCO ENVIRONMENTAL BEFORE STARTING WORK (802)770-6241</b>

SPECIAL PRECAUTIONS (CHECK ALL THAT APPLY AND DESCRIBE)	YES	NO	N/A	WHAT AVOIDANCE / MINIMIZATION MEASURES APPLY TO YOUR JOB?
EROSION / SEDIMENT CONTROLS	<input type="checkbox"/>	<input type="checkbox"/>	<input type="checkbox"/>	SILT FENCE / SEED AND MULCH / DEWATERING PLAN / OTHER
RARE, THREATENED OR ENDANGERED (RTE) SPECIES	<input type="checkbox"/>	<input type="checkbox"/>	<input type="checkbox"/>	FLAGGED / BARRICADED / SPOTTER REQUIRED / OTHER
WETLANDS & WETLAND BUFFERS	<input type="checkbox"/>	<input type="checkbox"/>	<input type="checkbox"/>	FLAGGING / MATTING REQUIRED
SURFACE WATER (STREAM, LAKE, POND, ETC.)	<input type="checkbox"/>	<input type="checkbox"/>	<input type="checkbox"/>	FLAGGING / MATTING REQUIRED
ARCHAEOLOGY (SITES/SENSITIVITY)	<input type="checkbox"/>	<input type="checkbox"/>	<input type="checkbox"/>	BARRICADED / MATTING RESTRICTIONS / OTHER
DRINKING WATER SUPPLIES (WELLS, SPRINGS)	<input type="checkbox"/>	<input type="checkbox"/>	<input type="checkbox"/>	TYPE / PROXIMITY / BARRICADED
SPILL RESPONSE KIT	<input type="checkbox"/>	<input type="checkbox"/>	<input type="checkbox"/>	WHERE IS IT? IS IT FULLY STOCKED?
OTHER / NOTES:				

## COMPLIANCE OVERSIGHT

The Environmental Inspector (EI), also called the Environmental Compliance Inspector or Compliance Inspector, whose specific duties are listed [above](#), is an integral part of VELCO's comprehensive approach to environmental compliance. EI may be members of the VELCO Environmental Team or a contracted resource. Through a proactive approach including planning, communication, and collaboration, the EI works with those responsible for performing the Work to ensure compliance of the project-specific permit conditions, applicable state and federal environmental rules and regulations, and VELCO's internal environmental policies and procedures. They are the main resource for contractors or maintenance crews while work is underway, and they maintain a consistent presence at the project site for the entirety of the Work. The EI serves to proactively identify and address environmental compliance risks in the field.

Environmental compliance reports produced by the EI weekly are submitted to the Environmental Team and project team; they document relevant work around natural resources, as well as anything of note (e.g. failed or improved ESPC measures, work in a new area, project changes, dry/frozen conditions, etc.). Environmental compliance reports and associated pictures are maintained in a VELCO geodatabase for reporting, as a reference for future projects, or as learning opportunities, if applicable.

## GENERAL WORK PRACTICES & PROCEDURES

### PRE-WORK SCOPING

The Pre-Work Scoping Checklist includes a detailed narrative of the work task/s to be performed, hazards associated with the Work, ROW considerations, and environmental concerns and mitigating measures. The Pre-Work Scoping Checklist is completed and circulated by the VELCO representative managing the Work. It is completed during the project planning phase, and its completion helps ensure the job scope, schedule, risks, and any necessary mitigating aspects are identified and vetted in advance. The VELCO Pre-work Scoping Procedure and Checklist is a component of and contained within the [VELCO Safety Manual](#).

## FLAGGING

VELCO uses standardized flagging colors/patterns to demarcate Sensitive Resources. This is to ensure that field flagging accurately identifies the Sensitive Resource and can be easily referenced to any project plans or mapbooks which use the same color/patterns.

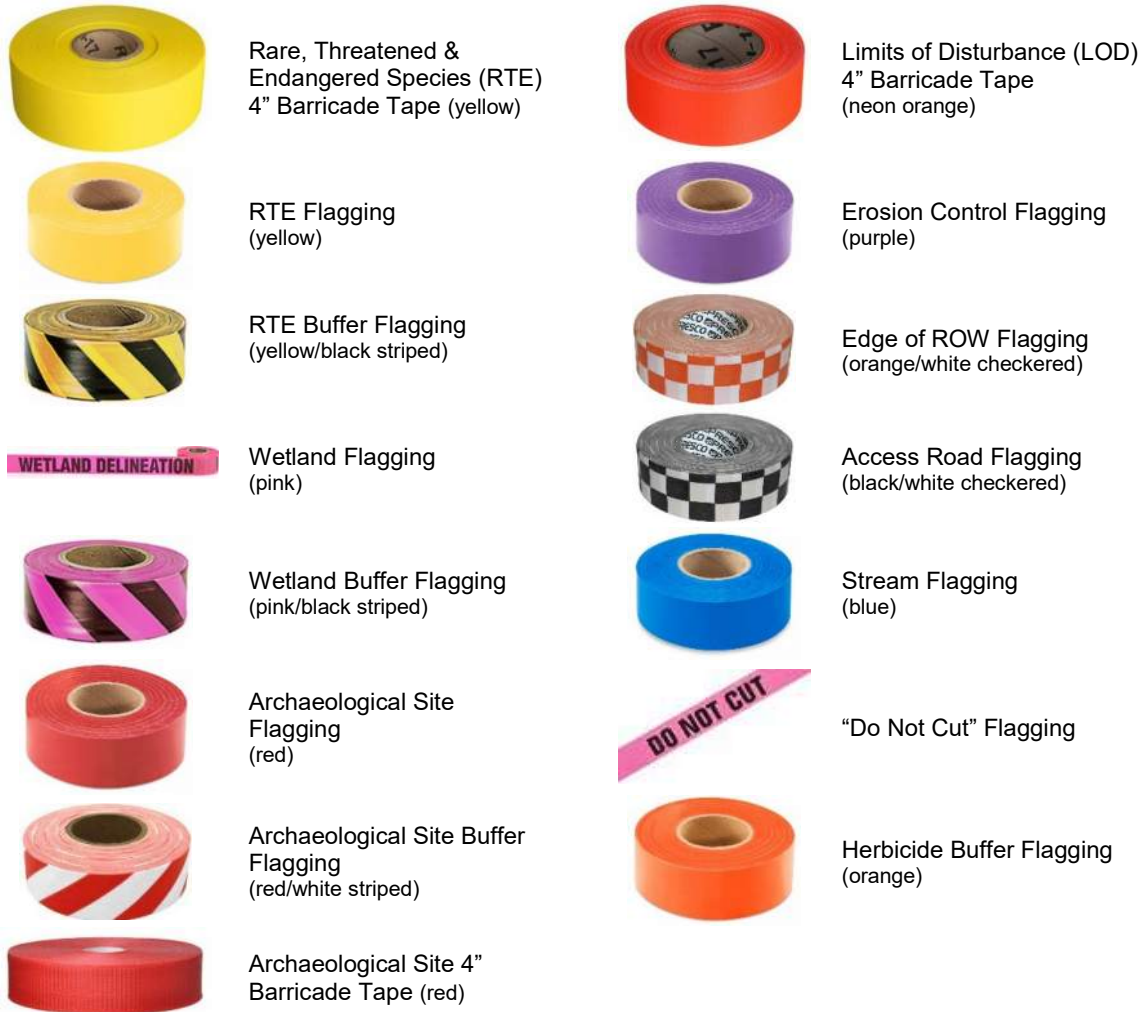

## ACCESS REVIEW

The purpose of this practice is to establish a streamlined approach to identifying and selecting suitable access routes for the construction and continued operation of electric transmission lines, substation facilities, telecommunications (radio and fiber assets) facilities, and related infrastructure. This review is a collaborative effort involving several VELCO departments (e.g., Environmental, Access & Vegetation Management, Construction, Right-of-Way, Telecom, and Line Crew), VELCO consultants, and the respective landowners. The inclusion of the appropriate stakeholders will expedite access selection, ensure proper review, and allow for faster approval of new access routes for use by work crews. VELCO strives to select access routes that avoid or minimize impacts to Protected Resource Areas, maximize the use of existing established routes, and allow equipment safe and efficient access to the site via public roadway crossings whereby minimizing the length and extent of new access route development. VELCO has designed the following procedure with respect to off-corridor access route selection.

## Access Selection Procedure

1. To the extent practicable, job sites should be accessed via public roads. When public road access is not feasible, access should be gained via existing, previously disturbed/developed routes. Examples of viable access routes include:
  - Farm roads
  - Log landing areas or logging roads
  - Recreational paths (e.g., ATV trails, VAST network)
  - Existing or former railroad beds
  - Private driveways or roads
2. If existing routes are not available or suitable for use, permanent or temporary access routes may be created through previously undisturbed areas with the appropriate permissions including approval from VELCO Environmental, ROW, and/or Legal.

### *Off-Corridor Access Route Planning and Approvals*

If access via an existing road is not available, off-corridor access routes will be identified/collected during the planning process in a manner consistent with VELCO data collection standards. The access route data should clearly identify the entire proposed access route from its point of origin at a public access point to the Work location/s. All off-corridor access routes, with the exception of existing improved roadways or paths (e.g., pavement, gravel, compacted dirt), shall include an appropriate level of review by VELCO's Environmental Team. Specifically:

- Access routes through environmentally sensitive areas (e.g., wetlands, stream crossings, and RTE species) will require additional review. When potential impacts are anticipated, VELCO will work to identify alternative access routes or develop impact mitigation measures consistent with applicable regulatory requirements.
- Access routes through known archeological sites/sensitive areas may require further archaeological investigation or route adjustment for avoidance as outlined in the [Archeological Section](#).
- Tree cutting and vegetation removal outside of normal ROW vegetation maintenance must be approved by the VELCO Environmental Team as this work can trigger the need for additional permitting and/or project review.

## Changes to Access Routes

All travel must be confined to access routes (both on- and off-corridor) that are approved for use through the Access Review Procedure. If it is necessary to change or alter access routes for any reason (e.g., turnarounds, laydowns/staging areas, or restoration practices), the VELCO Environmental Team must be consulted and the [Change Review Procedure](#) shall be followed.

## LOOK AHEAD PROCEDURE

The purpose of the Look Ahead procedure is to provide project construction personnel with the necessary environmental clearance to access and perform activities in the Work Areas, ensure effective

communication, and define roles and responsibilities. This procedure is intended to identify best work practices, communicate permit/regulatory requirements, and identify and mitigate obstacles that could hinder construction activities or lead to potential non-compliance events. It is performed in the field with appropriate personnel (Environmental, Access, ROW, Construction Coordinator/s, etc.).

The process for establishing clearance for Work Areas will be as follows:

1. VELCO and/or its Environmental Consultant/s will pre-inspect all Work Areas with both the Contractor and a Construction Coordinator to review and discuss applicable permits and guidelines to evaluate the planned work and associated compliance procedures.
2. Findings should be documented, as applicable, and distributed to the appropriate project personnel.
3. If appropriate at that time, survey crews or the Environmental Inspector will [flag/mark](#) Work Areas as required by applicable permits and guidelines. Protected resources may also be flagged during that time.

## CHANGE REVIEW PROCEDURE

The purpose of this procedure is to establish a process to properly document and approve any necessary modifications that occur once the planned Work is finalized and/or underway to ensure that the change is performed in accordance with regulatory requirements or previously documented processes.

1. If it is determined that a change to the approved project scope is necessary and confirmed with the project team (e.g., access width or routing, structure relocation, additional construction mats, etc.), the respective Contractor or Field/Access Coordinator (“Submitter”) shall submit the Project [Change Review Form](#) describing the basis for the requested change and a sketch of the proposed change to the VELCO Environmental Team via e-mail.
2. The Environmental Team will work with the Project Manager to review the proposed change/s and evaluate the environmental implications and permitting required (if any), level of effort and budget/schedule impacts associated with the change to determine if the change is feasible. If it is determined to be not feasible the request will be denied. If it is determined that the change is beneficial to the project without significant schedule delays or substantial cost implications the request may be approved.
3. The Project Team will engage the necessary resources if regulatory and/or landowner approval or consultation is required. The Submitter should be aware that it may take weeks or months to gain approval for changes that require regulatory approval.
4. Upon receipt of the necessary approvals, the request will be approved and communicated to the Project Team. Once the change has either been approved or denied, the Environmental Team will issue a response to the Submitter. The Environmental Team may also issue the amended plans to applicable project staff.
5. As part of this process, the Environmental Team will electronically update the project files to reflect the changes. Electronic and/or hard copies will be distributed to the appropriate project personnel, as needed.

## INCIDENT REPORTING

VELCO's Incident Reporting Procedure (see below) is designed to facilitate the prompt identification, reporting, and response to incidents of potential environmental non-compliance. Examples of permit or environmental non-compliances include:

- Placing unauthorized fill (including construction mats) in wetlands
- Unauthorized disturbance (including ruts) in wetlands
- Failure to adhere to EPSC plan provisions (e.g., failure to maintain silt fences, turbid runoff leaving work area)
- Unauthorized activities in archaeologically sensitive areas
- Unauthorized incidental takings of RTE species
- Unreported or negligent spills of OHM

It is expected that all Work is completed in line with our [Environmental Compliance Policy](#). All VELCO employees and contractors have a responsibility to ensure environmental compliance. "If you see something, say something." A determination as to whether an incident is an actual violation will be made by the VELCO Environmental Team and, where necessary, Legal Counsel. An [Environmental Incident Report](#) should be used to document the incident.

### Incident Reporting Procedure

1. Field personnel will secure the incident location and no further activity shall occur until a field investigation is conducted and instruction to proceed is received from the Environmental Team.
2. The incident shall be immediately reported to the project's Environmental Inspector and the Field and/or Access Coordinator/s.
3. The Environmental Inspector and/or Field and/or Access Coordinator/s shall immediately notify the Environmental Team of any incident.
4. Upon notification, the Environmental Team will review the incident and will notify the VELCO Legal Department and other VELCO personnel, as needed, and if necessary the team will work collaboratively to ensure timely notifications are made to the necessary regulatory agencies.
5. An on-site field investigation will be conducted cooperatively between the Environmental Inspector and Field and/or Access Coordinator, as soon as reasonably possible after the incident is reported. An incident report will be completed and submitted to VELCO Environmental on the same day or as soon as possible after the incident occurs to ensure timely resolution/response actions.
6. The VELCO Environmental Team will convene to:
  - Investigate the incident
  - Conduct field visits and interviews as necessary to ascertain facts
  - Determine the cause of the incident
  - Provide recommendations regarding corrective actions to prevent similar incidents from reoccurring.
7. At the same time, the incident will be evaluated by appropriate VELCO personnel for entry into



VELCO's Learning Opportunity process as a means for continuous learning and improvement. The process will be used for event analysis, tracking and trending, and follow-up action items.

8. By the end of next business day following the day of the incident, the VELCO Environmental Team will brief Management on the cause, recommendations, and proposed corrective actions.
9. Within 72 hours, the VELCO Environmental Team will work collaboratively with the Contractor and/or appropriate party/s to implement the necessary corrective measures. These measures will be discussed at the project construction meeting/s and documented in the meeting log/s as well as the Environmental Compliance Report, as applicable.
10. All field crews will be briefed during project meeting of new procedures, requirements, and/or lessons learned.

## UNANTICIPATED RESOURCE DISCOVERY RESPONSE PROCEDURE

Although most Work Areas have been assessed for the presence of protected resources in advance of the work, construction and maintenance activities have the potential to encounter previously unidentified features that warrant further analysis and/or avoidance. Examples of such features may include but are not limited to:

- Cultural resources
- RTE
- Wells/Drinking water supplies
- Landfill or waste dump
- Wetlands
- Streams
- Bat roost trees

If a work area is discovered to potentially contain unidentified protected resources by field personnel, the following process shall be followed:

1. Work in the area of the discovery should be immediately stopped.
2. The Environmental Team shall be promptly notified.
3. The Environmental Team shall perform a site inspection with construction personnel to discuss avoidance measures.
4. If the feature is able to be avoided, the area will be flagged with barrier tape or a similar protective barrier.
5. If the feature cannot be avoided, the Environmental Inspector or Environmental Team will perform a review to determine if the area was previously assessed.
6. A subject matter expert may be consulted on the item/s discovered. Further field assessment and agency notifications will be made depending on the findings of the subject matter expert's assessment.

Discovery of unanticipated cultural resources should follow the process outlined in the [Archaeological Section](#).



# **WASTE MANAGEMENT**

VELCO's strategy for waste management is to properly manage and dispose of waste while minimizing the amount of waste sent to the landfill and maximizing the amount of material sent for re-use, recycling, or reprocessing. This section provides waste management guidance for Work Crews by outlining the common waste streams that may be generated as part of planned construction and demolition work.

All waste generated must be managed in compliance with federal, state, and local requirements for the disposal of solid waste. Hazardous waste shall only be removed from the site by a hazardous waste service provider permitted in accordance with state and federal regulations. Materials with hazardous qualities and characteristics may require special handling and labeling while the material is in use/service. When a hazardous material has reached the end of its life and requires disposal it may become a Hazardous Waste which may require different handling, labeling, etc.

Contact the VELCO Environmental Team for assistance or with any questions regarding waste characterization and disposal requirements.

Prior to the commencement of Work, Work Crews should know and consider the following elements:

- Materials to be disposed of at each work site, such as:
  - Hazardous materials & wastes (asbestos, PCBs, etc.)
  - Universal wastes (mercury thermostat, florescent light tubes, etc.)
  - Treated wood (pentachlorophenol treated wood poles, cross arms, etc.)
  - Recyclables (metal, cardboard, etc.)
- Site specific areas of contamination and associated environmental remediation plans
- Appropriate on-site dumpster placement, signage, and accessibility
- Waste management services and proximity to disposal sites

## **GENERAL HOUSEKEEPING**

Work crews shall keep the Work Area clean and free of trash and debris to ensure site safety. Materials left behind have the potential to harm livestock, wildlife, and the environment. All construction and demolition debris and other trash at the Work Area shall be collected regularly (daily and/or weekly) for off-site disposal at an appropriately permitted facility. Do not bury trash or debris within fill or backfill. Open burning is not an allowed waste management strategy at VELCO.

Hazardous waste shall only be removed from a site by a hazardous waste transporter permitted in accordance with state and federal regulations. The responsible party shall ensure that all hazardous waste is labeled and stored in compliance with applicable regulations prior to shipment. The VELCO Environmental Team requires a copy of any manifest used to transport regulated materials from VELCO property and Work Areas, including the ROW, staging areas, lay-down yards, and access roads.

Contact the VELCO Environmental Team for assistance or with any questions regarding waste characterization and disposal requirements.

## ARCHITECTURAL WASTE

Architectural Waste is recyclable construction and demolition debris, such as drywall, metal, asphalt shingles, clean wood, plywood, and oriented strand board, and should not be disposed of at landfills. In accordance with Vermont Act 175, when a site produces 40 cubic yards or more of architectural waste and is within 20 miles of a facility that recycles Architectural Waste, then these materials must be brought to such a facility. The disposal or reuse of Architectural Waste shall be performed in conformance with applicable regulations, Project Plans and/or permit conditions.

## ASBESTOS

Prior to any demolition project, a hazardous building materials assessment should be performed in order to appropriately characterize the waste materials for the presence of asbestos. A qualified professional will be retained to perform an inspection of the suspect material/s and perform any necessary abatement work, in accordance with the applicable Vermont Department of Health and EPA rules and regulations. Any detected or suspect asbestos containing material is to be reported to the VELCO Safety Manager and VELCO Environmental.

## CONCRETE WASHOUT

Concrete wash water often contains a slurry of heavy metals, can be caustic, and has a high pH. As a result, concrete wash water is not a permitted discharge. If concrete washout is going to occur on site, a lined concrete washout basin should be installed on site (see attached detail [EPSC-17](#)). Prefabricated washout basins may also be utilized in accordance with manufacturer's specifications. The location of the washout basin should be included on site plans and/or approved by VELCO Environmental prior to use.

Concrete washout areas shall be constructed and maintained in sufficient quantity and size to contain all liquid and concrete waste generated by washout operations. Care should be taken to cover washout basins during storm events to prevent overtopping.

When a washout basin is nearing capacity, concrete wash water shall be pumped to a concrete truck, as necessary, for disposal or reuse at a batch plant. The washout may also be allowed to evaporate/harden for disposal in accordance with all applicable local, state, and federal regulations.

## E-WASTE

Electronic Waste or E-Waste such as computers, monitors, printers, computer peripherals, and televisions are banned from landfills in Vermont and must be disposed of properly. Since E-Wastes may contain toxic materials, they should be collected and stored on an impervious surface in a structure that prevents exposure to precipitation. Contact the VELCO Information Technology (IT) Department prior to the disposal VELCO-owned electronics. During the decommissioning or updating of some VELCO facilities (e.g., substations, radio sites, telecommunication facilities), E-Waste may be generated. All applicable state and federal rules and regulations should be followed to dispose to E-Waste properly. Contact VELCO Environmental for assistance or with any questions regarding waste characterization and disposal requirements.

## LEAD-BASED PAINT

Many buildings built before 1978 contain lead-based paint, however, lead is found in other materials commonly used in and around households and businesses. Prior to any demolition project, a hazardous building materials assessment should be performed in order to appropriately characterize the waste materials for the presence of lead. A qualified professional will be retained to perform an inspection of the suspect material/s and perform any necessary abatement work in accordance with the applicable Vermont Department of Health and EPA rules and regulations. Any detected or suspect lead containing material is to be reported to the VELCO Safety Manager and VELCO Environmental.

## PCBS

Polychlorinated biphenyls (PCBs) are human-made chemicals that were used in electrical equipment and some building materials before 1980. Transformers, capacitors, caulk, paint, glues, and fluorescent lighting ballasts are examples of products that may contain PCBs. The EPA banned manufacturing and certain uses of PCBs in 1979.

VELCO performed transformer oil processing, predominately in the 1980s and 1990s, to achieve non-PCB status (<50 ppm) for its di-electric mineral oil containing power transformers. However, due to historic leaks and equipment replacements/failures, the potential to encounter PCB-contaminated media in VELCO substations and storage yards still exists. As such, stations and facilities known to store or support transformers and/or capacitors shall be assessed for potential PCB contamination prior to any Work.

Work Crews shall conduct disposal of PCB containing material in conformance with Project Plans and permit conditions. PCB containing material shall be labeled and stored in compliance with applicable regulations prior to disposal at an appropriately permitted facility. VELCO Environmental requires a copy of any manifest used to transport regulated materials from VELCO property and Work Areas, including the ROW, staging areas, lay-down yard, and access roads. Contact VELCO Environmental for assistance or with any questions regarding waste characterization and disposal requirements.

## SOILS

Excess soil that meets Vermont Soil Standards is not a regulated waste and shall be reused on site using proper soil handling methods outlined in the [Excess Soils](#) section of this document. Work Crews shall conduct all soil excavation and soil re-use activities in conformance with the Project Plans and permits.

In some instances, it may be necessary to transport soil off-site for disposal at an appropriately permitted facility or receiving site. Soil that contains limited concentrations of polycyclic aromatic hydrocarbons (PAHs), arsenic, and/or lead may qualify as Development Soil under the Vermont Agency of Natural Resources' Investigation and Remediation of Contaminated Properties Rule ("IRule"). Alternative disposal and reuse options for Development Soil, such as use at a permitted solid waste disposal facility as alternative daily cover, shall be evaluated during the project planning phase and implemented when feasible.

Non-hazardous waste contaminated soil, including Petroleum Contaminated Soil, shall be handled and sent for disposal or treatment at an approved facility in accordance with the IRule and any site-specific approvals from officials at the VTANR Waste Management Division.

Soil contaminated with hazardous materials shall be managed in accordance with the Vermont Hazardous Waste Management Regulations and EPA rules and regulations. Hazardous waste contaminated soils shall only be removed from the site with approval from VELCO Environmental and by a hazardous waste transporter permitted in accordance with state and federal regulations.

VELCO Environmental requires a copy of any manifest used to transport regulated waste materials from VELCO property and Work Area, including the ROW, staging areas, lay-down yard, and access roads. Contact VELCO Environmental for assistance or with any questions regarding waste characterization and disposal requirements.

## SUBSTATION & UTILITY LINE MATERIALS

Decommissioned substation and overhead utility line materials shall be handled and disposed of in compliance with the applicable waste disposal rules and regulations. Metal equipment such as structural steel, chain link fence, disconnect switches, and the control building shall be recycled as scrap metal. Smaller oil-filled equipment, such as instrument voltage transformers and bushings, shall be handled and disposed of by a licensed commercial entity, whereby the oil is tested and recycled according to federal regulations and metal is recycled as scrap metal.

Computers, monitors, relays within control buildings, and some telecommunication equipment are considered [E-Wastes](#) and must be disposed of properly. See subsection above for more information.

Any equipment containing sulfur hexafluoride (SF6) gas shall be managed by VELCO's Asset Maintenance Substation Crew and decommissioned in accordance with the manufacturer's recommendations and procedures to ensure SF6 gas is not vented to the atmosphere. When retiring SF6 equipment, the gas shall be containerized into compressed gas cylinders for inventory quantification and recycling purposes. All decommissioning and disposal work should be performed in conformance with Project Plans and permit conditions.

## TREATED WOOD (PENTACHLOROPHENOL)

Wood products used for outdoor exposures, such as utility poles, are most often treated with chemical preservatives that create a barrier against insect attack and decay. Pentachlorophenol (Penta) is a common preservative used in wood utility poles that, in sufficient concentrations, can pose a risk to public health and the environment. Work Crews shall perform wood utility pole removal and replacement activities in accordance with the Penta BMPs identified in [Docket 8310 Appendix 1](#).

When reused appropriately, treated wood is not considered a waste. In the event that a VELCO Penta-treated utility pole or other treated-wood asset is considered for reuse, the recipient of the material/pole must be approved by VELCO. After approval, recipients shall be provided with the ANR Reuse Fact Sheet contained within Docket 8310 Appendix 1 and must sign the [Pole Waiver Form](#) indicating that they understand the risk associated with the material, the best management practices for reuse, and end-of-life disposal options.

Other treated wood may qualify as hazardous waste when discarded. Contact VELCO Environmental for assistance with waste characterization and disposal requirements.

## UNIVERSAL RECYCLING & COMPOSTING

In accordance with Vermont Act 148, the Universal Recycling and Composting Law, all listed recyclables, food scrap, yard debris, and clean wood, shall not be disposed of at landfills. Work crews shall make reasonable effort to reuse, repurpose, or recycle clean wood debris. Clean wood (“wood waste”) includes trees, untreated and unpainted wood including dimensional lumber and other natural woody debris.

Listed recyclables, such as aluminum and steel cans, aluminum foil and pie pans, glass bottles and jars from food and beverages, #1 and #2 (PET and HDPE) plastic, corrugated cardboard, white and mixed paper, newspaper, magazines, catalogues, paper mail, envelopes, and box board must also be recycled.

## UNIVERSAL WASTE

Low-risk hazardous wastes such as certain batteries, mercury-containing devices, fluorescent bulbs, and aerosol cans are banned from landfills in the State of Vermont and must be managed as Universal Waste. Universal Wastes must be collected separately and handled under the applicable universal waste regulations.

## USED & WASTE OIL

Used Oil, such as crankcase oils, transmission fluids, and hydraulic oils, is to be managed in accordance with the [Hazardous Materials and Spill Response](#) section of this document and sent to an appropriate Used Oil processing facility for recycling.

Off-specification Used Oil that cannot be sent for recycling, or any other oil product that can no longer be used for its intended purpose, must be collected separately from Used Oil and clearly labeled as “Waste Oil.” Waste Oil may need to undergo waste characterization prior to disposal at an applicable facility.

VELCO Environmental requires a copy of any manifest used to transport Used or Waste Oil from VELCO property and Work Area, including the ROW, staging areas, lay-down yard, and access roads. Under no circumstances may Used Oil or Waste Oil be applied to roads for dust suppression, be released to surface or groundwaters, or be released to the environment in any way. Contact VELCO Environmental for assistance or with any questions regarding waste characterization and disposal requirements.

## HAZARDOUS MATERIALS & SPILL RESPONSE

All efforts shall be made to ensure no Oil or Hazardous Material (OHM) are released into the environment.

VELCO has a robust compliance monitoring plan for all facilities and OHM containing equipment regulated under Title 40 CFR 112 and chapters 7, 8, and 9 of the Vermont Environmental Protection Rules, which is outlined in the *VELCO Substations and Facilities Spill Prevention and Control Countermeasure Plan (SPCC)*. Spill prevention measures are outlined for each substation and facility under normal operating conditions in the SPCC plan. For all other Work, the guidance below, as well as applicable state and federal regulations shall be followed.

## SPILL PREVENTION

Equipment that contains OHM shall be stored and maintained so that spills and leaks are prevented. Minimum spill prevention actions shall include:

- Daily inspections of the storage of oil and hazardous material-containing equipment including 55-gallon drums, fuel tanks, and oil-containing equipment (e.g. equipment with hydraulic hoses, etc.)
- Equipment containing oil should not be stored or left over night in Protected Resource Areas.
- Refueling should not occur within 50 feet of Protected Resource Areas.
- No leaky or inadequate oil or hazardous material containing equipment or storage containers shall be stored or used on VELCO properties, easements, or project sites. Any such equipment or materials must be removed from the site for the necessary repairs and/or replacement without spreading contamination.
- Spill response kits shall be kept on all OHM containing equipment and at all refueling stations. Kits shall be easily accessible and fully stocked.
- If the maximum total above ground storage capacity for oil of any kind at the total work area exceeds 1,320 gallons, a SPCC plan must be prepared and implemented as required by the federal SPCC Rule.
- VELCO may require the contractor to provide a spill prevention plan at any time during the performance of a project, regardless of the total oil storage capacity at the work area. This spill prevention plan will be provided before storing or using OHM on VELCO jobsites and shall be subject to review by Environmental and/or the project Environmental Inspector/s.

Other best practices to prevent spills of OHM are outlined in the subsequent subsections. These should be followed on VELCO job sites or Work Sites. VELCO reserves the right to require additional BMPs or measures.

### Equipment Check

Ensure equipment is properly maintained and hoses are in good condition. Equipment operators shall inspect equipment prior to daily operations, check for leaks and unsecured fittings, and document on the Tailboard form.

### Oil and Hazardous Material Storage

When storing OHM on a Work Site, regardless of whether an SPCC Plan is required, the following general procedures shall be followed:

1. An effort will be made to store only enough products required to perform the work.
2. All materials stored onsite will be stored in a neat, orderly manner and, if possible, under a roof or in a containment area. At a minimum, all containers will be stored with their lids on when not in use.
3. Prior to siting any storage tank larger than 50 gallons, VELCO Environmental shall be consulted to the proper location.
4. Drip pans shall be provided under all dispensers.

5. All storage containers will be clearly labeled, closed when not in use and placed on secondary containment pallets/basins under a roofed storage area or protected by berms/bunkers on an impervious surface. Temporary or mobile storage tanks shall be kept on secondary containment pallets/basins under a roofed storage area or protected by berms/bunkers on an impervious surface to the extent possible.
6. Equipment and storage containers holding oil or hazardous materials that are leaky or inadequate shall not be kept at the project site.
7. Products will be kept in their original containers with the original manufacturer's label in a legible condition.
8. Substances will not be mixed with one another unless recommended by the manufacturer.
9. Whenever possible, all of a product will be used before disposing of the container.
10. Manufacturer's recommendations for proper use and disposal will be followed for the disposal of the container and all surplus products.
11. [Safety Data Sheets \(SDS\)](#) for each product with hazardous properties that is used at the Work Site will be obtained and used for the proper management of potential wastes that may result from these products. The SDS will be made available to all project personnel.

## Maintenance of Equipment on the ROW

All vehicle or equipment maintenance shall be performed at least 50 feet from Protected Resource Areas and storm drains. The equipment operator shall take all reasonable precautions during maintenance activities to prevent an accidental spill. These precautions include the use of portable basins or similar secondary containment devices, use of ground covers such as polyethylene sheeting, and/or the use of containment booms and absorbent pads.

At VELCO's request, the work crew/s shall provide VELCO with written procedures for review and approval that will be followed for maintenance of the equipment while it is on any property subject to VELCO's control (e.g. ROWs, substations, etc.). The maintenance procedures shall address routine fluid changes, hydraulic hose replacements, containment while performing maintenance, etc.

VELCO reserves the right to require the work crew/s to remove specific equipment from the project if such equipment has had an unacceptable number of releases or poses an unacceptable risk of a release of OHM to the environment. Upon notification by VELCO, the work crew/s shall have two business days to remove the equipment from the site.

## Refueling

All vehicle refueling (or any other transfer of fuel, oil, or hazardous material) shall be performed at least 50 feet from Protected Resource Areas and storm drains. The equipment operator shall take all reasonable precautions during refueling and maintenance activities to prevent an accidental spill. These precautions include the use of portable basins or similar secondary containment devices, use of ground covers such as polyethylene sheeting, and/or the use of containment booms and absorbent pads.

The following procedures shall apply to all refueling and transfer operations:

1. No bulk deliveries shall take place without prior notification to VELCO.

2. Check all gauges and volumes prior to fuel transfer.
3. The delivery truck wheels shall be chocked as soon as the truck is parked in the fuel transfer position.
4. Before fueling, flexible transfer hoses shall be inspected for cuts, abrasion, and damaged ends.
5. All fuel transfers shall be monitored.
6. Tanks shall not be filled to overflow capacity.
7. Final inspection of the tank truck and tank feed lines shall be conducted to assure that all valves and ports are closed and that no leaks have occurred.

## Spill Kits

Spill kits provide an active countermeasure that can be deployed rapidly following the discovery of spills of OHM. Spill kits shall be kept in proximity to the work sites, on all pieces of equipment, where OHM are stored, and at all refueling stations. Spill kits shall be easily accessible at all times. VELCO reserves the right to require the work crew/s to provide additional spill kits.

Spill kits must be kept fully stocked. These kits should typically include the following:

### Personal safety wear:

- Tyvek® suit
- Aprons
- Shoe booties
- Chemical goggles
- Solvent resistant gloves

### Clean up equipment:

- Repair putty
- 55 gallon steel drum and hazardous waste label
- Drum liner
- Solvent resistant broom
- Non-spark and solvent resistant shovel
- Residue bags (50 count)

### Absorbents:

- Granular sorbent
- Sorbent booms
- Sorbent static resistant pads

Additionally, the contractor shall maintain smaller spill kits with each piece of mobile oil-containing equipment. Smaller spill kits typically include the following:

- |                    |                                |
|--------------------|--------------------------------|
| ▪ Absorbent socks  | ▪ Blank label for residue bags |
| ▪ Sorbent mat pads | ▪ Protective gloves            |
| ▪ Repair putty     | ▪ Tyvek® suit                  |
| ▪ Safety goggles   | ▪ Residue bag                  |

## Tailboard

Equipment checklists and inspections, spill kits, and storage and refueling of equipment around Protected Resource Areas are to be discussed as part of the safety Tailboard briefing.



## SPILL RESPONSE & CLEANUP PROCEDURE

Releases from VELCO or contractor facilities and equipment shall be the liability of the responsible party associated with any and all releases of oil and hazardous materials resulting from their employees' or subcontractors' equipment. Liability includes spill response; reporting; cleanup/remediation; all costs, fines or fees; and any other action required per applicable regulations. The handling, storage, utilization, and cleanup of any and all oil and hazardous material (OHM) must comply with all federal and state statutes, rules and regulations, as well as with VELCO's procedures.

Spills that occur at facilities and locations contained within the *VELCO Substations and Facilities Spill SPCC* and occur under normal operating procedures (e.g. transformer failure during normal operations) will follow spill protocols provided in the *SPCC* (see page ii of the *SPCC* for the Spill Response Quick Guide). Spills that occur during Work will follow the guidance below and any and all applicable state and/or federal regulations.

### Spill Response Actions

The responsible party shall be responsible for all spill response, clean up, environmental quality sampling and disposal. The work crew/s performing the testing, cleanup, and disposal activities must be properly trained to perform these work activities. VELCO, at its discretion, may require the services of a spill response contractor for any spill.

Immediate spill response actions include the following:

1. Stop the release if it is safe to do so (i.e. shut down the equipment).
2. Prevent the release from migrating into Protected Resource Areas through the deployment of spill booms, absorbent materials, sand bags, etc. If the spill occurs in a protected resource and it is safe to move the equipment without releasing additional OHM, do so.
3. Immediately notify VELCO Environmental or Environmental Inspector. If VELCO Environmental and/or the Environmental Inspector are unreachable, report the spill to the VELCO Control Center at 802-770-6261.

### Required Notifications

The following information shall be relayed to VELCO Environmental as soon as possible:

- Location of spill
- Source of spill (equipment, AST, vehicle, etc.)
- Time spill occurred and/or was discovered
- Estimates of quantity and type of oil/hazardous material spilled
- Whether the spilled material entered or is near any Protected Resource Areas (storm drain, stream, wetland, etc.)
- Determination of whether there the spill poses a potential or actual threat to human health and the environment
- Description of any containment and/or cleanup activities performed
- Any other pertinent information (ground conditions, access to spill site, current weather

conditions)

- Any injuries or threat of injuries
- Additional response actions needed and schedule of cleanup

VELCO staff shall perform the initial notifications to the VTANR, which requires immediate notification by telephone of spills and a written report within ten days following any discharge or release. In most cases, VELCO will make this initial notification on behalf of the contractor. Depending on the nature of the spill or discharge to the environment, it may be necessary to contact additional regulatory agencies. The agency to be contacted will depend on the nature and amount of the spilled material and the location of the spill.

## Spill Reporting

After proper notifications are made, VELCO Environmental will prepare a Spill Report on behalf of the responsible party. In certain circumstances at VELCO's request, the responsible party may be responsible for producing the Spill Report. A Spill Report must be created for all spills. For spills requiring reporting to regulatory agencies, VELCO Environmental will ensure the submission of a Spill Report as required.

The Spill Report shall document the OHM release including location, quantity, composition, proximity to Sensitive Resources, remedial actions, and process of disposal. In addition, the Spill Report may also include sampling results (if applicable), documentation of communication with VELCO and the responsible party about the spill, manifests, maps depicting the spill site and any Sensitive Resources, and description of the cleanup.

Any spills that were caused by negligence or the repeated failure of equipment may be evaluated for an [Incident Report](#). A Spill Report is to document a single, unexpected release of OHM.

## Cleanup & Remediation

VELCO Environmental will work with the responsible party to contain, cleanup, and dispose of released materials.

### *A. General Cleanup Requirements*

All cleanup of spills shall be conducted in accordance with the current Vermont Hazardous Waste Management Regulations, the Vermont Agency of Natural Resources' Investigation and Remediation of Contaminated Properties Rule ("IRule"), and any site-specific approvals from officials at the VTANR Waste Management Division. All personnel performing cleanup activities must be properly trained.

Contaminated soil and media should be cleaned up as soon as possible after the initial spill response has been completed, the source of the spill stopped, and the spill contained.

The work crew/s shall take appropriate steps to containerize all contaminated soil and media or to encapsulate petroleum-contaminated soil and debris on-site within plastic sheeting as appropriate for the specific situation. (Encapsulating means a protective barrier beneath and above the contaminated media, to protect the ground and prevent precipitation-causing runoff, respectively.) Unless otherwise directed by VELCO or the regulatory agency, the work crew/s shall ensure that all contaminated soil shall be excavated from the ground at the spill site and confirmatory samples, if applicable, are collected.

## ***B. Sampling***

When a spill warrants confirmatory sampling, a qualified environmental consultant will be contracted by the responsible party to ensure all state and federal regulatory requirements are met.

## ***C. Clean-Up Requirements***

Cleanup of contaminated material shall meet all applicable state and federal regulations. Petroleum contaminated soil and debris shall be managed in accordance with ANR requirements, and with case-by-case approval by VELCO and the ANR Waste Management Division. Soil and debris contaminated with hazardous materials other than petroleum shall be managed in accordance with the Vermont Hazardous Waste Management Regulations. When required by these regulations, corrective action and follow-up site investigations shall be conducted by a qualified environmental consultant in accordance with ANR requirements.

For petroleum-contaminated soil, the soil may be temporarily stockpiled on-site on plastic sheeting subject to the following conditions:

- 6-mil minimum thickness plastic sheeting above and below the contaminated soil,
- Sheeting securely anchored to soil pile to prevent wind damage and leaching,
- No sensitive receptors (water supply wells, storm drains, wetlands, streams, lakes and ponds, etc.) are adjacent to the temporary stockpile, and
- Adequate space is present to handle/manage the soil properly.

## ***D. Transportation and Disposal of the Contaminated Material***

The responsible party shall ensure proper disposal of all contaminated material, including all contaminated PPE, at a disposal facility that is approved by the VTANR and that meets the requirements of the Vermont Solid Waste Management Rules and the Vermont Hazardous Waste Management Regulations. When contaminated soil is to be transported off-site, additional laboratory testing may be required.

Hazardous waste shall only be removed from the site by a hazardous waste transporter permitted in accordance with state and federal regulations.

All contaminated media, including soils and clean-up materials must be properly disposed of. VELCO requires a copy of any manifest used to transport materials from VELCO property and Work Sites, including the ROW, staging areas, lay-down yard, and access roads. For smaller spills, cleanup materials may be disposed of at a work crew/s satellite accumulation site location (i.e. drum located at the contractor's shop) if the responsible party is able to provide documentation when that satellite receptacle is picked up for disposal.

# **EROSION PREVENTION & SEDIMENT CONTROL** **(EPSC)**

The following section provides an overview of VELCO's approach to EPSC and associated BMPs which are utilized during all VELCO work activities requiring soil disturbance. All Work Crews should follow any EPSC measures outlined on Project Plans or in Work-specific permits.

Major ground disturbing activities associated with VELCO construction and maintenance work include building access roads, grading for the installation of transmission line structures, substation construction, and communication facilities installation. Excessive soil disturbance associated with construction and maintenance activities without proper mitigation can result in soil erosion, sediment deposition, and pollution to surface waters, wetlands, and other sensitive resources. Several factors influence erosion on construction sites including rainfall, temperature, topography, soil type, and vegetation.

#### 10 Basic Principles of EPSC:

1. Minimize the area and duration of soil disturbance.
2. Maintain existing vegetation.
3. Promptly stabilize exposed soils with mulch, rolled erosion control product, hydroseeding, etc.
4. Retain existing topography as much as possible.
5. Perform work in dry conditions.
6. Limit vehicular/equipment access in areas of disturbance.
7. Divert offsite runoff (or “run-on” water) away from the project site and/or areas of disturbance.
8. Minimize length of disturbed slopes.
9. Inspect/maintain erosion control measures and soil stabilization efforts frequently and provide prompt maintenance as needed.
10. Revegetate areas as soon as possible following the completion of work.

## PROJECTS WITH STORMWATER PERMITS

For Projects that have a site-specific stormwater discharge permit, all permit conditions shall be followed. Any permit conditions supersede the guidance provided within this document.

## EPSC MEASURES

Typical erosion and sediment control measures include silt fence, filter sock, water bars, check dams, mulch, rolled erosion control product, and stabilized construction entrances among others. Erosion and sediment controls are installed between the work area and any sensitive resources and/or the project limits prior to the performance of earth-disturbing activities.

The following are typical EPSC BMPs that outline the correct usage of the control measures listed above:

- **Stabilize Exposed Soil:** Seeding and mulching, rolled erosion control product, and hydroseeding are typical methods to stabilize exposed soil.
  - Permanent or temporary stabilization must be completed within 7, 14, or 21 days (depending on the permit and time of year requirements) after initial disturbance.
  - After initial disturbance, stabilization must happen after each work day if there is disturbance, unless work is to continue in the disturbed area within the following 24 hours and there is no precipitation forecasted for the following 24 hours or if there is self-contained excavation of a depth 2 feet or greater.

- When mulch is used for soil stabilization efforts, it shall be applied at 4 tons/acre during the winter construction timeframe (October 15 to April 15) and 2 tons/acre during all other times of the year.
- **Stabilize Soil at Final Grade:** The construction site should be stabilized with seed, mulch, and/or erosion control matting as soon as possible when final grade is established.
- **Dust Control:** Throughout the project, if there is enough dust to cause a nuisance then water should be sprayed to dampen soils. If water is not sufficient, other dust control measures may need to be implemented in consultation with VELCO Environmental as project permits and regulations allow.
- **Perimeter Control:** When feasible a 25 foot minimum buffer should be maintained between the perimeter controls (silt fence or filter sock) and earth disturbance. Reinforced silt fence or two EPSC measures must be installed in areas that discharge within 50 feet of a sensitive resource.
- **Access Routes:** Stone check dams and water bars must be used at and along erodible access points/routes to reduce stormwater flow velocities and to divert overland flow to a stable and well vegetated upland location. If needed, control measures such as silt socks shall be installed at the discharge points to water bars to further reduce sediment transport. Measures shall be left in place until final stabilization is achieved, and permanent controls such as water bars or check-dams will remain after project completion to eliminate any on-going erosion risk.
- **Winter Construction BMPs:**
  - During the winter construction period (October 15 through April 15), areas of disturbed soils must be stabilized at the end of each work day unless work in the disturbed area will resume within 24 hours and there is no precipitation forecasted in that 24 hour window.
  - Snow and ice must be removed to less than one inch prior to applying stabilization measures.
  - Access points should be enlarged and stabilized to facilitate snow plowing/removal and stockpiling of snow, as needed. Limits of disturbance should be moved, within the limitations of the permits, to accommodate snow piles located down slope to prepare for snowmelt.
  - Snow plowing, removal, and stockpiling should not damage EPSC measures or LOD demarcations. Proper planning prior to snow removal activities is required to ensure that EPSC measures remain in proper working condition throughout the winter season. Any damage to EPSC measures shall be maintained, as soon as reasonably possible,
  - Drainage structures must be kept free of snow and ice.
  - For areas of disturbance within 100 feet of a waterbody, additional erosion control measures must be installed across the slope, down gradient of the earth disturbance. See the [Low Risk Site Handbook](#) for control measure options.

To stabilize disturbance areas prior to the winter construction period, permanent seeding needs to be done no later than September 15. In addition, vigorous vegetation establishment sufficient to bind soils and prevent erosion must be achieved prior to the end of the growing season. During frozen conditions, it may not be possible to install certain types of erosion controls. In such cases, suitable alternatives such as mulch stabilization, erosion control berms, or modified installations of typical erosion control measures can be utilized. Whenever erosion controls are installed, they must be regularly inspected and maintained to ensure that the controls are performing effectively.

Erosion and sediment controls shall be installed as indicated in Project Plans or as needed to prevent impacts to protected resources and to prevent sediment from leaving the site. For Work without an EPSC Plan or a Construction General Permit, such as maintenance work, the Low Risk Site Handbook can provide valuable guidance on siting and sizing erosion controls. Also see the attached details, and more information can be found in [The Vermont Standards and Specification for Erosion Prevention & Sediment Control](#) available from the VTANR Water Quality Division.

## GRADING ACTIVITIES

VELCO Work Crews shall limit disturbance to soil and vegetation to only the area necessary to safely operate equipment and execute the Work. When feasible, crews should conduct Work with the use of low impact or tracked equipment to avoid impacts to vegetation and soil, such as rutting or compaction.

EPSC measures shall be installed before the commencement of soil disturbing activities within the Work Area. Required grading of access routes and equipment pads must be performed in accordance with Project Plans and permits. Following the completion of Work, all disturbed soil should be properly seeded and stabilized to promote re-vegetation and to mitigate the risk of soil erosion. No excavation, grading, or soil disturbing activities shall occur within sensitive resources unless specifically authorized by Project permits or the Environmental Team.

For larger construction projects requiring permit coverage under the Vermont Stormwater Rules, the OSPC is responsible for amending the Project Plans to reflect any additional areas of disturbed soil such as access roads, equipment pads, etc. If the project is not a larger construction project but still requires permit coverage under the Vermont Stormwater Rules, the PIC is responsible for amending the Project Plans. However, all plan changes must be reviewed and approved by the Environmental Team prior to implementation. Changes to erosion control measures, such as deploying fixed controls in a different configuration or utilizing different controls than those contains in the EPSC Plan require prior review and approval by the Environmental Inspector or Environmental Team before use.

## CONSTRUCTION ENTRANCES

For construction projects, a construction entrance (see attached detail [EPSC-2](#)) is typically required when there is the potential for equipment to track loose soil onto a public roadway. Construction entrances should be constructed using clean, crushed stone placed atop geotextile fabric, which should extend laterally at least five feet beyond the edge of the clean stone. Once work is complete, the stone should be removed (depending on future access requirements) and the area should be restored. A construction entrance is not typically required for infrequent maintenance Work; however, maintenance crews should consult with the Environmental Team if the following conditions exist to evaluate the need for a construction entrance:

- Access for Work will be via a road with moderate to high traffic volume;
- Access is via a paved road;
- Field conditions are adverse (e.g., extremely wet, extremely muddy);
- Work is planned for an extended period; or
- A construction entrance is requested by the municipality.

## SOIL HANDLING ACTIVITIES

### Soil Segregation

Proper handling of soils involves the segregation of topsoil from subsoil. Topsoil should be stockpiled separately from subsoil and, during restoration, spread as a top dressing over the Work Area to better facilitate seeded vegetation growth or natural revegetation. For areas of [Prime Agricultural Soils](#) or in [Wetlands](#) refer to those sections for specific soil handling practices.

### Excess Soil

In upland Work Areas with no protected resources, any excess clean (free of contaminants and non-native invasive species) soil may be spread within the limits of disturbance and seeded and mulched to allow for revegetation. For wetland areas, all excess soil must be removed from the wetland and buffer (if applicable). Clean wetland soil can be transported to a suitable upland location away from protected resources and evenly spread and stabilized (see the [Wetlands Section](#) for more info on soil handling, backfill, and dispersal). If there is not a suitable upland area available on site for excess soil to be spread, the excess soil shall be taken off-site to a suitable soil disposal area or facility approved by the Environmental Team.

For contaminated soil, see the [Soils](#) subsection in Waste Management. For soils containing non-native invasive species (NNIS), see the [Invasive Species](#) section.

## SITE INSPECTIONS

### Active Construction

Most Work will require environmental inspections. Environmental inspections will be done by a qualified Environmental Inspector (EI) and/or a VELCO Environmental Team Member, generally, at least once every 7 days and/ or after every rainfall/snowmelt event. For Work subject to stormwater permitting as a “Moderate Risk” or an Individual Permit, inspections of EPSC measures shall be performed in accordance with all permit requirements by the OSPC or EPSC Specialist (if applicable). Inspection records shall be maintained until the Work Area is completely restored and re-vegetated. Inspections and any associated action items and maintenance shall be documented in the VELCO Environmental Inspection and Compliance Reporting tool.

### Inactive Construction Sites

For sites that have been temporarily stabilized for an extended period of time (e.g., during winter shutdowns) and at the discretion of the Environmental Team provided the environmental compliance risk is low and all permits are followed, environmental inspections may be reduced or paused until work activities resume or the site has reached final restoration.

### Post Construction & Final Inspection

After Work has been completed, the area has successfully revegetated, and field inspections have been performed by the Environmental Team, silt fences, silt sock and any other fixed erosion control measures



shall be removed for proper disposal. Hay or straw bales utilized for erosion controls may be used as mulch for disturbed areas. Silt fence, stakes, baling twine, fabric and any other associated debris shall be removed from the Work Area and disposed of appropriately.

## DEWATERING PROCEDURE

Dewatering activities may be necessary to complete certain Work activities. Water discharged from dewatering efforts may contain suspended sediments. If not managed properly, these dewatering activities could potentially create large amounts of sediment deposition upon discharge. This section is intended to be used as a general guide of BMPs for dewatering activities and should be used in collaboration with the project plans, agency permits, and site-specific characteristics. Necessity of dewatering efforts will be evaluated based on site conditions and shall be in accordance with the project plans and with the approval of the On-site Plan Coordinator (OSPC), Environmental Inspector, and/or VELCO's Environmental Team.

Prior to dewatering activities, a site-specific dewatering plan shall be developed outlining volume, discharge location, duration, and type of dewatering structure. The completed dewatering plan shall be reviewed and approved by the Environmental Team or their designee and may be submitted to the VTANR, if required. Monitoring is required throughout the dewatering activity to ensure compliance throughout the Work. Additional inspections may also be conducted by the Environmental Team.

### Dewatering Structure Placement

Dewatering structures should be located outside protected resources (e.g., wetlands, streams, archeological sites, RTE areas, and any associated buffers) to the fullest extent possible. For locations where dewatering activities cannot be practically located outside of protected resources specific alternatives must be reviewed and approved by the Environmental Team prior to initiating dewatering activities. Alternative setups may include, dewatering to tank, a filter bag dewatering setup, a dewatering discharge structure deployed on top of construction mats, or other alternatives that are protective of the resource/s. Large wetlands can be the most difficult resource to avoid during dewatering activities. Therefore, any dewatering activities situated within a wetland will be continuously monitored to ensure no turbid discharges occur. For more information about dewatering in and around wetlands please see Wetlands [Dewatering](#) subsection. Dewatering structures will not be constructed in streams, archeological sites, or proximate to RTE species.

It is necessary to evaluate each discharge location to determine if a dewatering basin is required or if dewatering to a splash pad in upland areas is feasible. The type and size of each dewatering structure will be determined by the Environmental Inspector in consultation with the project/look ahead team. For particularly challenging situations, consultation with VELCO's Environmental Team is recommended. Site characteristics that will be assessed when determining location type and size of dewatering basin include topography, soil types, depth of water table, vegetative cover, erosion potential, landowner concerns, and proximity to environmental and cultural resources.

Varying types and sizes of dewatering basins can be constructed. Dewatering basins must be properly constructed and monitored. The design of dewatering basins should be capable of handling all the sediment that will be discharged from the dewatering areas such that no sedimentation leaves the dewatering structures. Multiple structures may be necessary to adequately accept and process large flow volumes. The potential output of dewatering activities should be considered when designing the dewatering system. The system's capability to effectively contain the flow that will be realized from



pumping efforts as well as the system's ability to filter sediment loads will be evaluated when determining size and location of installation.

In some special cases, a vacuum and/or pump truck/s may be used to dewater in large wetlands or sensitive areas. There are various reasons for utilizing this method, such as very fine muck that cannot be augured or excavated easily, limited areas to dewater, sensitive resources nearby, etc. An off-site dewatering basin shall be set up in an approved upland location to discharge the vacuum/pump trucks to. All excess soil from the vacuum truck shall be disposed of at an approved site. Special precautions shall be taken to avoid the spread of invasive species; additional review by the Environmental Team is necessary if the area to be dewatered contains invasive species.

It is highly important to monitor dewatering activities regularly to ensure the system is functioning properly. Proper maintenance of dewatering basins includes the removal of excess sediments, regular inspections to assess structural integrity, and visual verification that no discharge of turbid water is occurring.

If Work has a site-specific stormwater discharge permit, all permit conditions shall be followed.

## RESTORATION

After work completion, VELCO and its contractors assume responsibility for the restoration of each access route and/or work area. Restoration items include, but are not limited to:

- Disturbed soil will be appropriately stabilized with seed and mulch to promote vegetative cover.
- Construction matting and temporary bridges will be removed.
- Temporary routes will be rough-graded to re-establish pre-existing contours.
- Stone construction entrances may be removed.
- Areas of significant soil compaction will be scarified to restore soil permeability and ensure vegetation establishment, as needed. If an access route is not permitted to be a permanent, impervious road, it will be scarified, mulched, and seeded to promote vegetative growth following construction.
- All erosion controls will be removed once the site has achieved permanent stabilization.

After Work has been completed, all used material and refuse should be removed from the ROW for proper disposal. Old poles should be removed and holes backfilled to grade. In some cases, old poles may be cut at or below the ground surface with the remaining section left in place. Removed material may be temporarily stored within the ROW pending removal and disposal. Old material should not be stored within wetlands, archeological areas, or other environmentally sensitive areas. Once the area has been restored and vegetation is fully established, a final site visit should be performed, adequately documented with photos and filed in the Project folder or with the VELCO Environmental Team.

The following subsections describe restoration activities that should be performed after Work has been completed.

### Disturbed Areas

Temporarily disturbed areas (except equipment pads and access routes) shall be returned to their original grade and stabilized with mulch and seeded with the appropriate seed mix (if sufficient root and seed stock are absent). If necessary, temporary equipment pads and access roads may be rough graded

(removal of stumps, boulders, steep slopes, etc.), to prepare an adequate seed bed for successful revegetation. These areas should then be stabilized with mulch or other appropriate soil stabilization measures. In steep areas where significant cut and fill occurs, slopes should be graded to a slope not greater than 2:1. In areas where a 2:1 slope is not practicable, additional or alternative stabilization measures may be needed.

Mulch used for temporary stabilization during the growing season (April 15-October 15) shall be applied as specified in the below table. During the winter construction period (October 15-April 15), mulch rates shall be doubled and weed free hay and straw mulch shall be tracked in to prevent removal by wind.

Mulch Material	Quality Standards	Per 1,000 Sq. Ft.	Per Acre	Notes
Wood chips or shavings	Air-dried; free of objectionable coarse material	500-900 lbs.	10-20 tons	2-7" depth of application
Wood fiber cellulose (partly digested wood fibers)	Made from natural wood usually with green dye and dispersing agent	50 lbs.	2,000 lbs.	--
Weed free hay or straw	Air-dried; free of undesirable seeds & coarse material	90-100 lbs. (2-3 bales)	2 tons (10-12 bales)	Cover about 90% surface

## Seed Mixes

For areas that require seeding, VELCO maintains in its warehouse a supply of seed mixes that have proven successful at revegetating even the most challenging areas. Other seed mixes may be necessary in certain locations, such as residential lawns and pollinator applications; refer to specific project plans and/or consult with VELCO Environmental. The standard seed mix (also referred to as wildlife seed mix or VELCO seed) and temporary seed mix should be applied via broadcast seeding at an application rate of not less than 25 pounds per acre. Wetland seed mix should be applied via broadcast seeding at an application rate of not less than 18 pounds per acre. Seed mixes should strive to meet the following mix weight ratios (these are periodically updated by VELCO Environmental in consultation with appropriate agency partners):

### Standard Seed Mix

(shall not be used with slopes greater than 2:1, within 50' of wetlands or streams, or in highly erodible soils)

SEED	WEIGHT
Climax Timothy	29.94%
Annual Ryegrass	14.77%
Fawn Fescue	9.81%
Potomac Orchard Grass	9.46%
Red Clover	6.51%
Perennial Rye Grass	4.95%
White Dutch Clover	3.26%
Ladino Clover	3.25%
Other Crop Grass	0.9%
Weed Seeds	0.7%
Inert Matter	17.88%

### Wetland Seed Mix

(use in all wetland areas)

SEED	WEIGHT
Blackwell Switch Grass	25%
Creeping Red Fescue	18%
Virginia Wild Rye	14%
Creeping Bentgrass	14%
Fox Sedge	13%
Riverbank Wild Rye	8%
Nodding Bur Marigold	3%
Soft Rush	2%
Sensitive Fem	1.5%
Blue Vervain	1%
Grey Dogwood	0.5%

### Temporary Seed Mix

(used in uplands between 10/1 and 5/14)

SEED	WEIGHT
Winter Rye	not less than 80%
Red Fescue (creeping)	not less than 4%
Perennial Rye Grass	not less than 3%
Red Clover	not less than 3%
Other Crop Grass	not less than 0.5%
Noxious Weed Seed	not less than 0.5%
Inert Matter	not more than 1%

## Improved Areas

Existing improved areas such as agricultural fields and lawns should be restored to a condition to that existed prior to the start of the Work unless otherwise dictated by easement language or landowner approval. All damage to property as a result of the Work should be documented and promptly repaired or replaced.

## Construction Mats

Following the completion of Work, all construction mats and temporary bridges shall be cleaned onsite, removed, and the area restored to pre-Work conditions. Special consideration should be taken in Protected Resource Areas; for more information see applicable resource sections (e.g. wetlands, archeology, etc.).

## Staging Areas and Construction Support Areas

Upon completion of Work, crews shall remove all work-related job trailers, temporary buildings, refuse, waste soil, and any unused material from the project area and any construction support/staging areas. All areas shall be restored to a stable condition to ensure that the work site is left in an environmentally sound condition. Final restoration of these sites should be documented in the Environmental Compliance Report.

## WETLANDS

Wetlands and Wetland Buffer Zones are routinely encountered during VELCO construction and maintenance work. Wetlands are areas of land that are either covered by water or saturated with water at or near the surface either seasonally or permanently. The plant species within wetlands have adapted to grow in wet soil. These areas are valuable ecosystems and water storage areas and also provide water filtration and reduce flood risks. Regulated wetlands in Vermont generally include a 50-foot buffer zone for State of Vermont Class II wetlands and a 100-foot buffer for State of Vermont Class I wetlands. (Please note that some wetland buffers differ from this general rule of 50 and 100 feet; see the Environmental Team if you have any questions.) Prior to commencement of work, regulatory requirements concerning wetlands shall be accounted for in applicable permits and plans.

When working in and around wetlands care must be taken to avoid impacts to the extent practicable and minimize any unavoidable impacts during the performance of Work. The following hierarchy shall be used when working in and around wetlands:

1. Avoid the wetland and/or buffer by siting work activities in uplands, if possible.
2. Minimize disturbance by using existing travel lanes.
3. Perform work during dry or frozen conditions.
4. Position wetland crossings at the point of least impact to functions and values, which is oftentimes the narrowest section.
5. Use temporary construction matting in wetland areas where ruts and significant soil disturbance is anticipated.
6. Construct temporary access roads using crushed stone on filter fabric.
7. Construct permanent roads.

## FLAGGING/SIGNAGE

During project planning and prior to construction or maintenance work activities wetland-specific flagging and signage should be installed to alert construction crews and field personnel to the presence of any wetlands and the type of Work that is to occur. Examples of flagging and signage can be found below. See the [Flagging](#) section above for standard VELCO flagging colors and patterns for protected resources.

Flagging Wetland Boundaries



Flagging Wetland Buffers



Temporary Matting

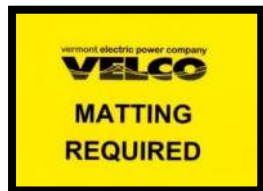

Wetland Fills



Wetland Avoidance



## FUELING

All refueling of vehicles, fuel storage tanks, and equipment (or any other transfer of fuel, oil, or hazardous materials) shall be performed away from wetlands by a minimum of 50 feet. For additional information on refueling, transfer, or the storage of fuel and OHM refer to the [Refueling](#) subsection within the Hazardous Materials & Spill Response section above.

## DRY/FROZEN CONDITIONS

Suitable frozen or dry ground conditions may exist for equipment access through and operation in wetlands without the use of construction mats. Dry/frozen ground conditions allow work without causing impacts to sensitive wetland environments.

Prior to access under these conditions, a dry/frozen evaluation must be performed by the Environmental Team or Environmental Inspector to identify work areas or access within and through wetlands which may become dry or frozen enough to work in without utilizing temporary fill (construction mats) and without

adversely affecting the wetland. The evaluation ensures that the following criteria are present for dry/frozen ground activities to be permissible:

- Access and work in wetlands will be performed with the use of low impact or tracked vehicles.
- Site conditions are suitable to minimize inadvertent adverse effects on wetlands (such as soil rutting deeper than approximately 6 inches) and the destruction of vegetation root systems beyond the capacity of natural re-vegetation. Suitable soil conditions include:
  - frozen ground,
  - low flow or low ground water conditions,
  - unsaturated surface soil conditions, or
  - where wetland soils consist of silt loam or soil textures and composition sufficient to resist excessive rutting, the mixing of surface and subsurface soil layers, the movement or re-deposition of soils in the affected area, or the need to restore the contours or hydrologic condition of the wetland.

With these conditions present, the determination to allow work in a wetland or buffer zone without the use of construction mats will be made by a VELCO Environmental Team Member or an Environmental Inspector in collaboration with a VELCO Field Coordinator or a construction contractor supervisor. The findings of this evaluation shall be documented in an Environmental Monitoring or Inspection Report as appropriate; the approval to work in dry/frozen conditions shall be documented in an email to the requester. If dry/frozen conditions are confirmed during an evaluation, the determination expires and requires reauthorization from the Environmental Team if environmental and/or ground conditions change or every 24 hours. The use of low impact construction equipment is required for work under these conditions.

Freezing an access route, i.e. purposeful repeated travel through an area on frozen ground using low impact tracked equipment, has proven effective in increasing the longevity of a frozen access road or work pad. The repeated tracking of equipment can increase the depth of the frost layer which prolongs the use of the frozen ground conditions in the area. Additional measures, such as pumping water, can also promote frozen conditions. An assessment for non-native invasive species should be performed before freezing an access route. Viable plant material (seed heads and tubers) may be present even in winter and shall not be transported to unaffected areas of the wetland by any work activities.

After construction or maintenance work in dry/frozen ground conditions is complete, wetland soils will be allowed to naturally regenerate vegetation from existing root and seed stock. In areas where wetland grades (such as sloped wetlands or seeps) pose an erosion hazard, annual rye seed may be cast over disturbed soils for temporary soil stabilization until natural vegetation sprouts unless special permit conditions stipulate otherwise. If disturbed soils are observed within a wetland, straw mulch must be applied to the area. Use of hay mulch is prohibited in wetland resources.

## CONSTRUCTION MATTING REQUIREMENTS

Work in wetlands oftentimes requires the use of temporary construction matting to support equipment access while also minimizing environmental impacts. Note that construction matting may also be used in upland and wetland buffer zones areas to protect existing vegetation, mitigate soil disturbance/impacts (e.g., rutting, compaction, etc.), and improve travel efficiency and safety.

The need for construction mats should be evaluated as part of project scoping in advance of work and verified as part of the [Look Ahead Procedure](#). Construction mats shall be used as outlined in project permits and/or shown on project plans which reflect authorized quantities and allowable use limits and were designed to reflect USACE and/or State of Vermont Wetlands Office BMPs. If the Work being performed does not require a permit matting may still be necessary. All matting in wetlands must be approved by VELCO Environmental. During construction projects and maintenance activities, unforeseen or unavoidable site conditions can result in the need for minor realignment of access routes or work areas or the need for additional construction matting. The Environmental Team must be contacted when a change is necessary as agency reviews or authorizations may be necessary. If a change is deemed necessary, the [Change Review Procedure](#) will be followed.

When multiple layers of matting or runners are needed to support construction equipment care should be taken to note the layers or number of construction mats used on project plans to ensure that all construction matting is removed and accounted for.

Temporary construction mats are to be carried and placed in the wetland. Dragging, pushing, or dropping of construction mats is not permissible within wetlands or their protected buffer zones as these handling methods may disturb and/or compact the soil. See attached [Access Details](#) for typical access road and mat deployments. Alternatives to typical details can be found the VELCO Access Construction Manual.

Travel along construction matting roads and equipment setup on construction matting shall be performed in a safe manner utilizing appropriate equipment for the work task and seasonal conditions. Equipment vehicular speed shall be kept slow to prevent unnecessary damage to the wetland environment. After a snowfall, matting may be brushed or plowed to remove clean snow from the mats to ensure safer working conditions. Snow, if clean, may be stockpiled on the mats on the edge of pads or pushed off of the mats. If sanding is necessary, sand may be applied to icy or snowy construction mats; however, snow with sand applied may not be plowed off mats onto the wetlands. Sand must be removed first (by brushing) before snow plowing may occur. No sand or dirt contaminated snow may be plowed into wetland or buffer zones. Snow removal from upland areas shall not be moved or stockpiled in wetland area.

Maintenance of construction matting may be needed, for example, if excess soil is tracked onto the access road from adjacent upland areas. Construction mats shall be cleaned of excess soil or debris by sweeping or shoveling the material for disposal to an upland location. The excess soil or debris shall not be deposited in the wetland or buffer zone.

At the completion of a project or maintenance activity, construction mats will be removed within project authorization timelines/limits or within a timely manner if timelines are not specified. Mats will be cleaned in an upland area prior to use in another wetland or before being moved to another site. Any soil from cleaning activities will be stabilized, and erosion and sediment controls must be deployed as needed. During the construction mat removal process, VELCO personnel or a designee shall monitor the work and area where matting is being removed from on a daily basis to ensure that all mats are removed from the wetland and project areas. Once mats are fully removed, the Environmental Inspector will perform a final walk through of the wetland to confirm the complete removal of all construction mats including pieces of mat broken off during use and installation and removal. If disturbed soils are observed within a wetland resource, straw mulch must be applied to the area. Use of hay mulch is prohibited in wetland resources.

## SOIL HANDLING

If the permitted Work involves excavation in wetlands or buffer zones, special care must be taken when handling soils. Excavated wetland soils will be stockpiled atop construction matting with approval from the Environmental Team, stockpiled atop filter fabric if construction matting is not available, or, if work space is constrained, can be placed within a dump truck if available for use during the excavation activity. If dry or frozen wetland conditions are present, excavated soil may be stockpiled on the ground surface provided the area was properly inspected for suitability prior to the performance of work or direct stockpile of soils. If soils will be backfilled into the excavated area, top soils must be segregated from subsoils and stockpiled separately. Soils should be backfilled in reverse order to maintain the existing soil horizons, substrates, and existing root and seed stocks. If backfill material is deemed unsuitable, rock or crushed stone may be utilized for the installation of the structure. Any excess rock or stone must be removed from the wetland and spread in an upland location away from resource areas. All excess soils from the Work must be removed from the wetland and transported to a suitable upland location (away from protected resources) and evenly spread and stabilized. If there is not a suitable upland area available on site for excess soil to be spread, the excess soil shall be taken to a soil disposal facility approved by the Environmental Team and appropriate soil disposal processes followed. Excavation areas must be brought to pre-existing grade.

## DEWATERING

Dewatering in and around wetlands should be performed in conformance with all permits (if applicable) and guidance provided in the [Dewatering Procedure and Dewatering Structure Placement Subsections](#) in the Erosion Prevention & Sediment Control (EPSC) Section above.

## PERMANENT FILL ROADS

If the need for the construction of permanent fill roads or permanent wetland fill is needed on a VELCO project, the Environmental Team shall perform a review of the proposed need and consult with applicable regulatory agencies to determine if the proposed fill requires agency review and permit approval. The construction of fill roads, once permission is granted or permits are received, shall be constructed using approved and suitable fill material. Material will be stabilized as needed to prevent erosion and sedimentation of the wetland and resource area. Fill roads through wetlands should ensure the hydrologic connection of the surrounding wetland to the greatest extent possible. Fill shall only be placed following all applicable requirements, conditions, or authorizations under the supervision of the Environmental Team or Environmental Inspector.

## STABILIZATION AND RESTORATION

As soon as reasonably possible upon completion of work in wetlands, final restoration and stabilization will be performed to ensure the functions and values of the wetland are maintained. The extent and type of final restoration and stabilization is based on the work activity that occurred within the wetland. Stabilization of disturbed earth in wetlands shall consist of straw mulch or rolled erosion control product (RECP) to mitigate the risk of the spread of invasive plant species.

For pole, structure, and anchor installation and replacement work or work in a wetland under dry or frozen conditions, the wetland will be returned to the pre-existing grade and the existing seed and root stock



allowed to regenerate. Following the completion of work utilizing construction matting, temporary bridging, or temporary fill, the temporary fill (mats, bridge, or stone on fabric) will be removed and wetlands will be allowed to naturally regenerate from existing root and seed stock. Where an erosion and/or sedimentation concern is observed and conditions warrant, annual rye or the VELCO wetland seed mix may be cast over the area to facilitate a more rapid restoration. See [Seed Mixes](#) subsection above for the wetland seed mix seed makeup with weight ratios.

## EMERGENCY ACTIVITIES

During unexpected occurrences that could potentially result in a hazard to life or a significant loss of property or impact to reliability, VELCO may perform emergency work to maintain VELCO infrastructure to allow for worker and public safety. Performing emergency work in wetlands to maintain and repair VELCO infrastructure is allowed under certain conditions. If emergency work is identified, work crews/supervisor shall consult with the Environmental Team. VELCO Environmental will then consult with USACE and Vermont Wetlands to expedite any necessary authorizations and permits for work that was performed under emergency work provisions.

## STREAMS

The term “stream” has many definitions as described in technical papers, regulatory documents, guidance documents, and throughout literature. The VELCO Environmental Team has developed the following description that provides a thorough, comprehensive and accurate depiction of the necessary physical characteristics that must be present to qualify a feature as a stream and thus make it subject to this guidance document and applicable state and federal regulations.

**Stream:** A watercourse that flows water by gravity for at least a portion of the year, through a natural channel created from concentrated flow, containing a clearly identifiable streambed and banks, where the streambed is unvegetated due to regular inundation and the bank slopes confine normal flows of the active channel.

The majority of streams in the vicinity of Work conducted on VELCO rights-of-way and properties are first and second order ephemeral and intermittent streams. Impacts to streams, such as at crossing locations, should be minimized whenever feasible. While VELCO corridors do cross large streams and rivers, most of the larger streams or rivers encountered are impractical to cross for the purposes of VELCO activities. As such, this guidance document is intended to focus on the most typical characteristics of streams that will be encountered, applicable stream crossing structures, best practices, and stream restoration. If the avoidance of larger streams and rivers is not practical, a separate and more thorough data collection, engineering, design, and permitting effort may be required.

## FLAGGING

During project planning and prior to construction or maintenance work activities in or around streams, flagging should be installed to alert construction crews and field personnel to the presence of any streams. VELCO uses blue flagging to demarcate streams which correlates with the color used on Geonet and mapbook. See the [Flagging](#) section above for standard VELCO flagging colors and patterns for protected resources.



## STREAM ASSESSMENTS

Once a feature is determined to be a stream, there are a number of characteristics that need to be identified in order to design and select an appropriate stream crossing methodology, as well as to ensure compliance with state and federal regulations.

The first characteristic that should be evaluated when identifying a stream crossing location is the elevation of the stream during the regular bankfull discharge. The bankfull discharge is generally described as the regular high water event, which occurs on average every 1.5 years. The elevation of the water during the bankfull discharge is referred to as the bankfull elevation, which is generally synonymous with the USACE's use of "ordinary high water" (OHW) and, in some instances, can also be synonymous with the top of bank elevation. The bankfull elevation at a stream crossing location can be determined by performing an in-field evaluation or by using historical data of a well-studied stream crossing location. Any person assessing the stream and determining the bankfull elevation should have sufficient education and/or experience to perform such an evaluation and make such a determination.

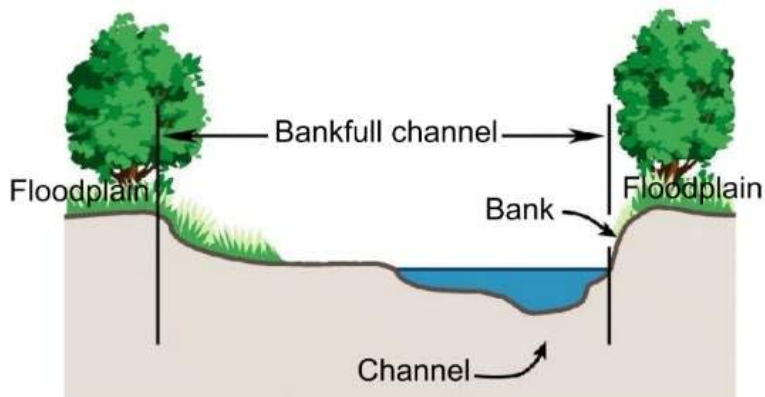

Once the bankfull elevation is determined on both sides of the stream at a specific location, these two elevations should be marked and measured in a straight line perpendicular to the flow of the stream to find the bankfull width. Bankfull elevations and widths can vary greatly throughout the length of the stream. It is important to assess significant lengths of the stream both upstream and downstream of the crossing location to get a complete understanding of the stream morphology. Sections of the stream that are similar in characteristics to the crossing location, free of human impacts (recent or historical), and are in a general state of equilibrium are referred to as a reference reach. When performing stream assessments, it is important to ensure the data being collected at the stream crossing location is being compared and analyzed against the data from the reference reach.

Additional characteristics that must be determined in the area of the stream crossing are the Top of Bank and/or the Top of Slope, which are defined by the VTANR in the Riparian Buffers and Corridors Technical Papers as:

**Top of Bank:** The point along the stream bank where an abrupt change in slope is evident and where the stream is generally able to overflow the banks and enter the adjacent floodplain during flows at or exceeding the average annual high water stage.

**Top of Slope:** A break in slopes adjacent to steep-banked streams that have little or no floodplain or a break in slope where the side slopes adjacent to an incised or deeply cut channel meet floodplains that have been abandoned or are undergoing abandonment.

Another key piece of data that must be identified and understood at each stream crossing location is the size of the drainage area. The drainage area provides information needed when designing the size, shape, height and alignment of the crossing, as well as, it is a key indicator of whether or not the crossing structure will require agency authorization. This effort is typically performed utilizing existing topographic

and watershed data. There are a number of ways to calculate the drainage area of a certain location and many methods are acceptable. This data is also helpful in determining the flow regime of the stream.

There are three specific flow regimes of streams; ephemeral, intermittent, and perennial. All three types of streams are encountered on VELCO ROW's and facilities. Ephemeral, intermittent and perennial streams, as defined by the VTANR Vermont Stream Geomorphic Assessment (VSGA) glossary are outlined below.

**Perennial Stream:** One which flows continuously.

**Intermittent Stream:** Any nonpermanent flowing drainage feature having a definable channel and evidence of scour or deposition. This includes what are sometimes referred to as ephemeral streams if they meet these two criteria.

**Ephemeral Stream:** A stream that flows only in direct response to precipitation and whose channel is at all times above the water table.

Identifying whether a stream is perennial, intermittent, or ephemeral in conjunction with other physical stream and watershed characteristics will illustrate the overall stability of stream, which may limit the type and configuration of the stream crossing structure. Ephemeral and intermittent streams may allow for limited crossing structures based on the time of year, magnitude of the work to be performed and the type/size of the equipment required to traverse the stream.

Identifying the location of the stream's thalweg in relation to the stream crossing location is important to understand how the flow and force of the stream is directed and could affect the stream crossing structure. The term thalweg means:

**Thalweg:** The longitudinal line connecting the deepest points of the stream where forces and flow velocity of the stream are the greatest.

Wherever possible, stream crossing structures should be designed so that the thalweg of the stream is centered through or beneath the center of the stream crossing structure. Stream crossing structures should avoid realignment, constriction, diversion, and/or alteration of the stream's thalweg. Significant alteration of the stream's thalweg without proper analysis and planning could have significant impacts to the physical and biological characteristics of the stream and limit the effectiveness of the crossing structure.

## AQUATIC ORGANISM PASSAGE

The presence of aquatic organisms (e.g., macroinvertebrates, amphibians, and cold and warm water fish species) is an important consideration when designing stream crossing structures. This is due to many inadequately designed or constructed stream crossing structures which have led to the fragmentation of aquatic habitats. As such, it is imperative that stream crossing locations be assessed by a qualified individual and the selected stream crossing include the considerations as described in *Guidelines for the Design of Stream/Road Crossings for Passage of Aquatic Organisms in Vermont*.

Stream crossings structures installed in streams supporting aquatic organisms should be installed in such a way as to allow for the native aquatic organisms to pass freely both upstream and downstream with minimal impact on the substrate. Generally, a stream crossing structure should ensure that a stream's physical characteristics upstream, downstream, and beneath the stream crossing structure, remain consistent without substantial changes that might inhibit aquatic organism passage.

Aquatic organism passage is less of a concern when considering the design of temporary crossing structures, provided the stream crossing structure would not substantially hinder an aquatic organism's passage during its important migration periods. Scenarios involving migration periods will need to be reviewed and approved on a case-by-case basis by a member of the VELCO Environmental Team.

## RIPARIAN BUFFERS

Protection and minimization of the impacts to riparian buffers must be taken into consideration in the design and installation of stream crossing structures. VTANR's definitions of riparian buffers in the Riparian Buffers and Corridors Technical Papers and VSGA Appendix Q are essentially the same. The definition in the Riparian Buffers and Corridors Technical Papers is described as:

**Riparian Buffer Zone:** The width of land adjacent to lakes or streams between the top of the bank or top of slope or mean water level and the edge of other land uses. Riparian buffer zones are typically undisturbed areas, consisting of trees, shrubs, ground cover plants, duff layer, and naturally vegetated uneven ground surface, that protect the waterbody and the adjacent riparian corridor ecosystem from the impact of these land uses.

Given that riparian buffers vary at each crossing location, it is important to assess the significance of the functions and values the riparian buffer provides in the vicinity of the proposed crossing location. During the Project planning phase, applicable stream crossing structure configurations should be evaluated and selected in a manner that minimizes impacts to riparian buffers to the extent possible.

## FLOOD HAZARD AREAS AND RIVER CORRIDORS

Work within Flood Hazard Areas and Rivers Corridors must be taken into consideration during planning, maintenance, and construction work. Flood Hazard Areas and River Corridors vary through river, stream, and riparian systems and need to be confirmed during the planning or scoping phase, prior to performing work. Flood Hazard Areas can be found through maps published by the Federal Emergency Management Agency (FEMA), and both Flood Hazard Areas and River Corridors can be found through the [VTANR Online Atlas mapping tool](#).

The Vermont Flood Hazard Area and River Corridor Rule allows for utility work to be conducted through permit approval and exemptions further outlined within the rule, based on the scope and intent of the project, and through the definition of "utility network" which are above or below ground linear facilities subject to 30 V.S.A. § 248 or 248a. In addition to the Vermont Flood Hazard Area and River Corridor Rule, projects need to account for the standards found within the Flood Hazard Area and River Corridor Protection Procedure for projects subject to Act 250 (10 V.S.A. § 6001 et seq.) and/or Section 248 (30 V.S.A. §§ 248 and 248a).

Generally projects associated with VELCO maintenance and construction work will be subject to exemptions found within the Vermont Flood Hazard Area and River Corridor Rule and do not require approval or permit issuance. Exempted activities are as follows:

1. The removal of a structure or the removal of any other improvement to property in whole or in part that is located in a Flood Hazard Area or River Corridor so long as the ground elevations under and adjacent to the removed structure or improvement remain unchanged.
2. Maintenance or repair of development in the usual course of business. This does not include

substantial improvements to structures.

3. Repair, maintenance, replacement, or reconstruction of transportation and utility networks provided that they are of approximately the same vertical and horizontal dimension. This exemption shall include the repaving of transportation networks.

For example, utility pole structure replacements in Flood Hazard Areas and River Corridors are allowed provided they are an in-kind replacement, do not move closer to the Flood Hazard Area or River Corridor, do not involve the movement of onsite soils (outside of normal structure replacement), and there is no grading or importation of fill that results in a permanent change in the elevation of the site. Temporary movement of fill (less than 180 days) prior to restoration and temporary construction matting is also considered exempt and does not require approval or permit issuance.

For projects that cannot be performed within the limits of exemption category, approval through a General Permit or Individual Permit based on project scope and applicability with the Vermont Flood Hazard Area and River Corridor Rule and Flood Hazard Area and River Corridor Protection Procedure will be required prior to the Work commencing.

## STREAM CROSSING STRUCTURES

Stream crossing structures must be adequately designed and constructed to avoid restricting flow during regular high water events, to withstand the forces of regular high water events, to maintain existing low flows, allow for natural sediment transport, and to not obstruct the movement or passage of aquatic organisms. To the extent possible, stream crossing structures should be located on straight stretches of stream, perpendicular to the flow, and where the stream's thalweg is generally located in the middle of the stream channel. Realignment of the stream channel should be avoided to minimize impacts to the stream channel and banks. If it is necessary to realign a stream channel or perform any significant amount of work within the top of banks of the stream or on the approaches to the stream in order to install a specific crossing structure, then VELCO Environmental personnel must review and approve the proposed design prior initiating any such work.

There are two categories of stream crossings: temporary crossings and permanent crossings. It is important to establish whether a crossing will be a temporary or a permanent crossing as early in the project planning phase as possible, since all other aspects of the design will be based on this information.

The design of stream crossing structures will vary based on the terrain, type of equipment and material available, what size and type of equipment will need to utilize the crossing, and the type of stream present. Stream crossing structures may also be designed for a certain Q rating, which refers to the recurrence of flood flow interval per years (e.g., Q25 means the flood flow having a recurrence interval of 25 years). The following subsections describe typical stream crossing structures that may be utilized in transmission line construction and maintenance.

### Mat Bridges

Mat bridges are the most common temporary stream crossing structure utilized on VELCO projects. Mat bridges can be constructed in a number of different ways, which makes them very versatile where variable field conditions exist. When constructing mat bridges, it is important from safety and environmental aspects to ensure that all mats used are in good condition and can support the weight of the equipment. Although typically constructed using heavy duty timber mats, other laminated or flat mats

may be utilized on the top layer to reinforce the bridge span and to catch sediment tracked onto the bridge. It should be noted that other laminated or flat mats may not be load bearing.

Mat bridges should span from top of bank to top of bank. Mat bridges should also have at least one stream bank abutment mat on each side to protect the integrity of the stream banks (see attached [Wetland/Stream Crossing Details](#) for more information). Whenever possible, mat bridge abutments should be set back away from the top of bank. This displaces pressure further from the stream banks instead of directly down onto them, preventing bank failure and potential sediment discharge to the stream, as well as, providing increased structural stability to the bridge. Timber mats come in a number of different sizes. Typical sizes range from 8 to 12 inches thick, by 4 feet wide, by 16, 18, 20, 24, or 40 feet long. In some instances, it may be necessary to provide structural support to the bridge, by placing additional mats in the stream beneath the bridge span. This activity must be approved by VELCO Environmental prior to installation. Mat bridges should span a minimum of 1.0 times the bankfull width of the stream at the stream bed elevation and have adequate headwater clearance above the lowest point of the bridge to accommodate potential water elevation changes. For more details, refer to the attached [mat bridge detail](#).

## Culverts

Culverts are commonly installed as permanent stream crossing structures, however, they may also be used as a temporary crossing structures due to safety or specialized equipment access. When designed and installed correctly, culverts are effective stream crossing structures and can last for many years. When designed or installed improperly, culverts can fail or lead to stream incision, aggradation and degradation, streambed and bank erosion, channel instability, and the degradation of aquatic organism habitat. There are numerous sizes and types of culverts, all of which serve to provide different functions. Types of culverts include: HDPE circular smooth and corrugated culverts, steel circular smooth and corrugated culverts, steel corrugated squash culverts, bottomless arch culverts, circular smooth concrete culverts, and box culverts. Each type of culvert is designed to perform differently and to be utilized in certain circumstances.

Culverts must be sized accordingly to accept peak flow volumes. Permanent culverts should be designed to at a minimum to the Q50 flow event. In addition to peak flows, there are other physical characteristics that must be considered in the design of the culvert, and failure to incorporate all necessary criteria can have detrimental effects.

Improperly designed or constructed culverts can be a significant obstacle for aquatic organism passage. Generally, bottomless box and arch culverts are less of a hindrance to aquatic organism passage than other types of culverts with bottoms or circular culverts. Circular culverts and culverts with bottoms should be embedded in the substrate approximately 20 to 40 percent, and be as wide, if not wider than, the bankfull width of the stream at the crossing location. Native substrate or similar material should be spread throughout the culvert, and the slope of the culvert should match the slope of the stream. Outlets should not be perched, allowing the water depth within the culvert to be roughly the same as within the stream, both upstream and downstream. Further [typical culvert specs](#) can be found the attached details.

Once the installation of the culvert is complete the streambed and substrate upstream, within, and downstream of the culvert should be generally consistent with each other and with the natural substrate of the stream. Failure to incorporate these considerations into the culvert design and installation could have impacts on aquatic organisms. Improperly designed or installed culverts can have both physical and biological impacts to the watercourse.

## Stabilized Fords

Stabilized fords may be utilized for both temporary and permanent stream crossings. Fords need to be constructed and maintained appropriately to ensure that they remain safe and environmentally sound. When determining whether fording a stream is appropriate, there are several items that should be considered. Specifically, the approaches to and from the stream should be comprised of stable material and have a gradual slope to and from the stream substrate. The potential impacts from the type of equipment that will be utilizing the ford and the number of anticipated passes should also be taken into consideration.

If it is determined a ford is the most appropriate crossing structure, equipment should be cleaned and inspected before the ford is used. Equipment should be free of observable soil and vegetation, as well as, petroleum or other hazardous products including, but not limited to, gasoline, engine oil, hydraulic oil, grease (including excess grease around fittings), diesel fuel, and anti-freeze.

## Brush Matting

Brush matting is generally not a preferred stream crossing method. However, temporary brush crossings, utilized under certain conditions, may be the most effective method available. Brush matting should only be used for necessary limited access under frozen ground conditions and when streams are generally less than 6 feet wide. Streams should have minimal flowing water at the time of crossing, the brush should be of sufficient size to support crossing equipment and brush matting should be placed in such a way as to protect the streambed and banks. Upon completion of use, all material must be removed from the stream. The crossing should not significantly hinder, block, or divert flow within the stream channel.

## Prefabricated Bridges

Prefabricated bridges are sometimes utilized on construction and maintenance projects. They are temporary structures, which are generally made from steel and are often longer and stronger than temporary bridges constructed from wooden mats. Although, prefabricated bridges may be more difficult to transport and install, many times they offer a more robust and safer crossing structure, especially for longer span lengths. Prefabricated bridges are generally used to cross perennial streams and they should span a minimum of 1.0 times the bankfull width of the stream and be elevated to Q25 headwater depth plus 1 foot above the lowest point of the bridge. When possible abutments should be set back away from the top of bank. This displaces pressure further from the stream banks instead of directly down onto them, preventing bank failure and potential sediment discharge to the stream, as well as, providing increased structural stability to the bridge.

## Ice Bridges

Ice bridges are not practical for general everyday stream crossings, however in certain situations they can be extremely effective, cost efficient, and environmentally preferable. Ice bridges can be effective stream crossing structures in situations where large streams or rivers must be crossed to reach isolated areas that have no other access, such as on islands or topographically constrained areas. There are a lot factors to consider regarding the construction of an ice bridge, such as the duration the crossing is needed, the type of equipment that will need to utilize the crossing, and the time of year. Ice bridges are temporary crossing structures, which are seasonally and temperature dependent, and must be reviewed and approved by VELCO Environmental and/or regulatory agencies prior to installation. When constructed properly, ice bridges can save a lot of in-stream work such as, water diversion, dam and



pump efforts, impacts to stream banks for approaches, installation and removal of alternative bridge materials, and restoration work. Additional, advantages include limited planning and engineering efforts, and potentially less environmental impacts and associated permitting issues.

Construction of an ice bridge is fairly straight forward, however the actual bridge dimensions and thickness should be provided by an engineer. Generally, an ice bridge will be constructed approximately 30 feet wide and will require 24+ inches of ice thickness. Once the exact details of the bridge have been established by an engineer, they may need to be provided to the regulatory agencies for review and/or authorization prior to commencement of work.

In order to construct a suitable ice bridge, the stream must be frozen enough to support foot traffic and small hand held equipment, such as a generator and pump, and must have flowing water deep enough to pump from throughout the construction process. Once these preliminary requirements have been met, crews should complete a safety briefing and initiate work. First, sidewall retaining structures are necessary to allow ice to build up within them in order to make a flat driving surface, so that equipment does not slide off the ice bridge in either direction. This can be accomplished by lining up straw bales end to end from one bank to the other on both the upstream side and the downstream side at the appropriate width of the ice bridge.

When the straw bales are in place and tightly pushed together, the next step is to start spraying or pumping water. This is generally accomplished by creating an auger hole through the ice on the outside of the straw bales on either the upstream or downstream side, and in the middle of the stream. Then, the suction end of the pump can be submerged in the water and start pumping water between the straw bales. All generators and/or pumps containing petroleum or other hazardous materials should be placed in secondary containment, and any additional fuel or oil be stored in an upland location away from the stream where accidental releases will not reach the stream or other protected resources.

As Work Crews begin to pump water into the bridge area, it is imperative to spray down the straw bales and saturate them. Once they are saturated, they will freeze and form a seal allowing water to build up within the straw bales and start to form the ice bridge. It is likely that the straw bales will have to be saturated numerous times, before they will freeze solid enough to retain the majority of the water on the bridge. It will be necessary to cut the baling twine on the straw bales, after they are frozen, but before they are buried in ice. This will allow the bales to slowly dissipate downstream with the thawing ice, versus creating a potential build up or temporary damming in the stream.

Once the bales will hold water, crews can pump water between the bales allowing ice to form until it is the appropriate thickness and quality as specified by the engineers. An effort of this nature will likely take a few days to complete, and is highly dependent of the temperature at the time of the efforts. Temperatures below 15°F are preferable. It is important to have solid ice, free of air bubbles to improve the strength of the ice bridge. When pumping water on the ice bridge, Work Crews should take care not to spray the water and to pump at lesser volumes to avoid the formation of air bubbles. This will help ensure solid consistent ice formation throughout the ice bridge.

## **Permanent Bridges**

Permanent bridges are becoming increasingly more common in utility line ROWs. This is due to changing regulations, increased reliability standards, the need for more permanent access to the ROW, more severe weather events and the large size and complexity of utility equipment. These bridges are similar to what is installed on transportation networks with concrete abutments, steel beam construction and appropriate decking material. Permanent bridges are engineered to the needs of the specific stream

crossing location and the size and weight of the equipment that will be utilizing the bridge. Permanent bridges are generally used to cross perennial streams and they should span a minimum of 1.0 times the bankfull width of the stream and have sufficient clearance to accept and pass the flows of a Q100 flood event. After a flood event, permanent bridges should be inspected. Most permanent bridges require permitting/regulatory approval.

## **STREAM EROSION PREVENTION AND SEDIMENT CONTROL**

Discharges of sediment and/or turbid water to streams and other aquatic resources can have significant impacts on both the physical and biological characteristics of the resource. These discharges can impact aquatic organisms, fill in floodplain areas, alter stream substrate material, hinder aquatic organism passage, contribute to aggradation or degradation of the stream, and contribute to water pollution. Therefore, efforts should be taken to limit erosion and to control sediment in the vicinity of stream crossings.

### **Stabilization**

There can be numerous difficulties related to standard erosion prevention and sediment control measures at stream crossing locations. For instance, the approaches to a stream crossing structure in mountainous terrain generally descend a hill until they reach the stream. If the approaches are used on a regular basis and not stabilized with appropriate material, they are typically void of any substantial vegetation and many times will develop ruts leading down to the stream. The lack of vegetation allows stormwater or shallow groundwater which has surfaced, to flow freely across the ground surface without disruption and increase flow velocities. This allows for soil suspension and the movement of sediment that can cause rill and gully erosion, eventually leading to a turbid discharge into the stream. If not properly planned for in advance, this common scenario can be difficult to control.

Stabilization of the approaches to a stream can be an effective practice to prevent erosion and minimize the risk of sediment and/or turbid water from entering the stream. Stabilization is most effective when planned for and installed prior to significant soil disturbance. Stabilizing the approaches is typically achieved by installing stone, gravel or construction mats on the travelled portion of the approaches. In addition, proper stabilization allows soil and sediment from vehicular travel to be released and dispersed on the stabilized areas prior to reaching the stream crossing.

### **Water Source Control**

Water source control is another effective practice to manage erosion and sedimentation, especially where the stabilization of the approaches is not feasible or economically viable. Water source control prevents water from coming from reaching highly erosive velocities, which limits erosions and sedimentation, thus preventing turbid discharges. Water bars, ditches, and culverts (not stream crossing culverts) are all examples of water source control features. These features can be used along access routes to divert and control water flow. Although very effective when installed properly these features require routine monitoring and maintenance to remain effective. Additionally, any water diverted by these features must have an appropriate discharge location. Appropriate discharge locations will vary depending on the specific characteristics of each site but typically involve discharging to an upland location that is adequately vegetated or reinforced with stone to provide sufficient treatment prior to reaching a stream or other protected resource. Ditches used in conjunction with source control are typically constructed on the uphill side of the road and must be adequately stabilized (e.g., vegetation, erosion control blankets, rock lined) and have sufficient water treatment (e.g., rock check dams, rock lining, etc.) prior to any discharge water reaching the stream.



## Stream Crossing EPSC BMPs

Frequent use of the stream crossing can lead to tracking of sediment onto the stream crossing structure, leading to sediment discharge to the stream. Therefore, it may be necessary to clean the stream crossing structures of soil and sediment accumulation at the end of each day, before each precipitation event, or as needed throughout the work day.

Routine cleaning of the stream crossing structure is easily accomplished on structures that have relatively flat travel surfaces. Generally, a small excavator can clean the majority of the soil. Hand tools, such as flat shovels and brooms, can be used to remove the remaining soil and debris. Stream crossing structures that are anticipated to be utilized during less than optimal weather conditions where tracking of sediment or other accumulation of sediment is expected on the stream crossing structure, the crossing should be constructed with a raised containing structure on both sides of the crossing structure. Examples of this include headwalls on culverts and curbing on bridges.

Although fixed erosion controls have certain limitations in many stream crossing situations, they can be very effective when utilized adjacent to the access roads in protecting the stream from discharges. See detail drawings for more information. If a turbid discharge to a stream is identified, corrective actions to stop the discharge shall be implemented as soon as reasonably practicable, and VELCO Environmental shall be contacted immediately.

## RESTORATION

The amount of restoration required at each stream crossing location is dependent on the particular site. For instance, a permanent stream crossing location will likely not require as much restoration effort as a temporary crossing would. Similarly, as a stream crossing in a relatively flat area would likely not require as much restoration efforts as one located in steep terrain.

Permanent stream crossings should be routinely inspected to ensure that they continue to remain in safe working condition as well as to ensure that they are not degrading and/or causing environmental impacts to the stream or surrounding environment. Upon completion of the installation efforts, any disturbed area surrounding the site should be seeded and stabilized. Every effort should be made to achieve permanent stabilization surrounding the site as soon as reasonably possible to safeguard against potential discharges and potential impacts associated with unanticipated flood events. Access routes should also be stabilized as described above in the [Stream Erosion Protection and Sediment Control Stabilization](#) subsection and in accordance with other sections of this document.

Temporary crossings typically require more restoration work than permanent crossings at the time of removal, however once removed and restored, they generally do not require ongoing inspections. When removing temporary crossing structures it is important to completely remove all material that was part of the crossing structure. Care should be taken at all times during installation, removal, and restoration to protect the streambed, banks, and surrounding vegetation. If the stream banks or floodplain have been altered from the installation or removal of the crossing structure, they should be restored to their approximate preconstruction elevations and should match/blend with both the upstream and downstream banks and floodplain. Once this is complete, the area should be appropriately seeded and stabilized. As with the permanent crossing, it is important to achieve permanent stabilization as soon as possible.

In some situations it may be desirable or necessary to stabilize slopes or banks with vegetation such as compatible shrubs or other woody plants. This type of planting may be warranted if bank or slope

stabilization is primarily dependent on root masses binding soils together to prevent erosion and where routine access is not expected. This is typically encountered in streams where higher flow velocities are encountered, subjecting the banks to stronger erosive forces. In most of these situations this type of stabilization can be accomplished by “live staking” of woody species. All seed and live stake plantings should be native species to Vermont and compatible with habitat where they are being planted.

## **RARE, THREATENED & ENDANGERED SPECIES**

Rare, Threatened, and Endangered (RTE) plant and animal species occur throughout the VELCO system and may be encountered when performing Work. Known locations are logged in the Environmental geodatabase, but due to the nature of plant species, new populations or unknown occurrences may still be encountered. All personnel performing Work on behalf of VELCO should stop work and follow the [Unanticipated Resource Discovery Response Procedure](#) if they encounter unexpected RTE species.

If RTE species (also referred to as “known occurrence”, “RTE population”, or “mapped polygon”) are present within a planned work area, the Environmental Team shall be contacted to review the work plan before Work starts. Work in and around RTE species listed as Threatened or Endangered within Vermont, must be performed in accordance with the *Best Management Practices for the Avoidance of Listed Threatened and Endangered Species for Operations and Maintenance Activities* (also referred to as the T&E BMPs). Prior to performing Work, all crews must review project plans and/or mapping for the presence of RTE species. For work occurring in or around RTE species within Vermont not listed as Threatened or Endangered, RTE species located in adjoining states (MA, NH, NY) or species listed as federally Threatened or Endangered, crews shall contact the Environmental Team for consultation prior to starting any work within the vicinity of the species. Daily Tailboard briefings shall also document any RTE species within or adjacent to the work area and the work plan to complete the required activities within or adjacent to mapped polygon/s to ensure species protection and compliance.

### **T&E BMPS**

Below is small subsection of the T&E BMPs that are the most commonly applicable to VELCO’s work; specifically as it relates to working in and around T&E plant species. This is not a comprehensive summary of the T&E BMPs. Crews working in and around T&E species must read and understand the T&E BMPs document and work with the Environmental Team to ensure compliance and protection of these limited resources.

The T&E BMPs outline the preferred order in which Work is conducted for both Vegetation Management and operations and maintenance (O&M) work around T&E plant species as:

- Option 1: Avoidance of T&E population polygon, or
- Option 2: Avoidance of plants within T&E population polygon during the growing season
  - 2a: Flagging for avoidance, or
  - 2b: Biological monitor during activities, or
  - 2c: Crew surveys concurrent to activities, or
- Option 3: Conduct O&M activities (no grading) within the T&E population polygon during dormancy period

- Option 4: Submit notification to VTANR for alternative practices
- Emergency O&M Activity BMPs

The VELCO Environmental Team will work with the project team and/or those conducting the work to determine the best option to protect RTE species while conducting the Work. The T&E BMPs document shall be consulted to make that determination.

Since the onset of white nose syndrome, many bat species around the country have been in decline which has prompted their listing as threatened or endangered. Please consult with the Environmental Team for the most current guidance on all threatened or endangered species.

## FLAGGING/SIGNAGE

Prior to Work starting, RTE or protected resource flagging and signage will be installed to alert construction crews and field personnel to the presence of RTE species, polygons, or Protected Resource Areas and the intended type of avoidance or impact that will occur across or within the area. RTE or protected resource flagging found on the VELCO system is yellow flagging; RTE or protected resource buffer zone flagging is a yellow and black striped. A 4-inch wide yellow barrier flagging is also utilized during construction and maintenance projects for the avoidance and demarcation of protected resources and polygons to alert crews where access or work area restrictions exist on project sites. Variations of signage alerting of RTE and protected resources may also be utilized during a construction or maintenance project involving work around or within other protected resources. Signage used within and around RTE or protected resources may state: "PROTECTED RESOURCE AREA EARTH DISTURBANCE PROHIBITED CONTACT ENVIRONMENTAL INSPECTOR WITH QUESTIONS". Examples of flagging and signage can be found below. Also see the [Flagging](#) section of this document for a comprehensive list of VELCO flagging standard colors.

This flagging and signage system may not always be feasible for large RTE polygon areas such as large RTE bat habitat areas. Alternative flagging/signage may be deployed or other arrangements of demarcation made in consultation with the work crews as necessary. Therefore, it is imperative for work crews to consult the environmental resource mapping daily and work with their VELCO contacts and the Environmental Team regularly.



## WORK IN RTE POLYGONS

Often construction and maintenance activity work needs to be performed throughout the year within RTE polygon areas. If polygon areas or individual RTE species cannot be avoided during the work activity, the Work will need to be performed during the dormancy period which typically extends from October 15 to April 15. Variations on dormancy periods for RTE species exist and must be confirmed by specific RTE species data sheets. Work during the dormancy period within a RTE polygon or species population must

be reviewed by the Environmental Team to ensure that avoidance and minimization of disruption to the population is performed. Construction matting is typically a viable option for the protection of Vermont listed species during the dormancy period for equipment access and/or setup. If construction matting is unfeasible for a particular location or work activity and grading or other activities need to be performed to complete construction and maintenance activities the Environmental Team shall be notified. Consultation with Vermont Fish and Wildlife will be performed for a notification of alternative practices or the submission of a T&E Takings Permit Application.

If maintenance work constitutes an emergency, such as due to transmission line reliability and safety or responding to storm damage, Operations staff shall notify the Environmental Team of the emergency work. The Environmental Team will then perform a review of RTE polygon mapping and notify Vermont Fish and Wildlife of the intended activities.

For additional information and details regarding time of year work restrictions and emergency consult with the VELCO Environmental Team who can provide the full T&E BMPs document and other guidance prior to conducting the work activity.

## **NON-NATIVE INVASIVE SPECIES (NNIS) MONITORING & CONTROL**

VELCO Work may occur in areas with NNIS, which are species that cause harm to the environment, economy, or human, animal, or plant health. They are species that can significantly disrupt habitats and negatively impact the ecological health and diversity of natural systems. Some of the most commonly encountered NNIS species in Vermont are:



Common Reed (Phragmites)



Japanese Barberry



Common Barberry



Common Buckthorn



Glossy Buckthorn



Purple Loosestrife



Japanese Knotweed



Honeysuckle (certain varieties)

Because of their potential for harm, VELCO has taken a three-pronged, proactive approach to working in areas with NNIS: 1) prevent project- and maintenance-related transport of noxious plant biological material into or out of VELCO work areas, 2) increase the opportunity for native plants to establish after soil disturbance, and 3) protect sensitive environmental resources by minimizing the spread of NNIS species.

## AVOIDANCE AND MINIMIZATION MEASURES

Wherever Work requires earth disturbance, VELCO or its designee (contractors, subcontractors, etc.) will proactively implement the following BMPs to prevent the spread of NNIS populations:

1. If possible, avoid Work in areas with NNIS.
2. Ensure that all contractors and onsite personnel receive training regarding NNIS, including the general identification of the documented NNIS species in the area and their locations and extent.
3. To reduce the introduction of NNIS to VELCO Work areas, all construction equipment (including construction mats) will be cleaned of observable soil and vegetation prior to entering Work areas. Further, previously utilized equipment (including construction mats) on a Work site that is suspected of having encountered NNIS populations shall be cleaned of observable soil and vegetation prior to moving to alternate work locations or leaving the Work area.
4. Topsoil and seed mixes used for temporary or permanent stabilization in disturbed areas shall be free of NNIS species (per *The Vermont Standards and Specifications for Erosion Prevention and Sediment Control*, 2020).
5. Wherever topsoil is salvaged from an area containing a pre-existing NNIS population that cannot be eradicated so as to be considered NNIS-free through chemical, physical or mechanical control, it shall be re-utilized in either the same location or a Work area that already contains that NNIS species and not transported to other Project areas to the extent practicable.
  - a. If relocation of NNIS containing topsoil into a non-NNIS area is unavoidable, it shall be temporarily stockpiled on and covered with secured tarps or heavy plastic until permanent disposal is possible or buried beneath a 24-inch or greater layer of NNIS-free soil or other select backfill material. These measures will minimize the opportunity for NNIS seed and plant fragments from expanding into areas of disturbed soils.
6. When constrained sites restrict onsite disposal as outlined above, offsite disposal of NNIS material and/or NNIS containing topsoil may be a required management control activity. The offsite transport and disposal of NNIS and/or NNIS containing topsoil must be covered during transport and transport vehicles swept clean at the location transported to. Offsite disposal of NNIS containing soil/woody debris shall be reviewed and approved by VELCO Environmental



prior to its implementation to ensure alignment with the Vermont Agency of Agriculture, Food & Markets (AAFM) Quarantine Rule and that it accomplishes the general intent of reducing the overall impact of NNIS weeds on the environment.

For certain Work, VELCO will develop a project-specific NNIS Monitoring and Control Plan which may outline more extensive efforts including post construction monitoring. Examples of those plans may be viewed on individual project pages on VELCO's website.

See VELCO's Transmission Vegetation Management Plan for additional details as they pertain to vegetation management and treatments.

## **OTHER SENSITIVE RESOURCES**

As part of VELCO's work, other sensitive resources may be encountered. Some of these may include, but are not limited to, Natural Communities, deer wintering areas, bear habitat, ospreys and their nests, grassland birds and their habitat, Prime Agricultural soils, and drinking water supplies. This list is not extensive and VELCO Environmental should be consulted if Work encounters other sensitive resources not outlined in the subsections below prior to performing Work.

### **NATURAL COMMUNITIES AND RARE AND IRREPLACEABLE NATURAL AREAS (RINA)**

A Natural Community is an interacting assemblage of plants and animals, their physical environment, and the natural processes that affect them. Identifiable assemblages of plants and animals that repeat across the landscape wherever similar environmental conditions occur are categorized into Natural Community types. Natural Communities provide a powerful tool for describing the landscape, developing sound management plans for land, determining conservation priorities, and increasing our understanding of the natural world. VTANR provides guidelines for the conservation of significant natural communities to conserve biological diversity and to provide timber resources, wildlife habitat, and outdoor recreation.

State-Significant or other highly significant natural communities may further be designated as a Rare and Irreplaceable Natural Area (RINA) through an Act 250 or Section 248 petition. RINAs are determined on a case-by-case basis and are protected against undue, adverse effects. Work performed in a RINA should preserve the qualities and character of the area and may require special considerations for cutting and maintenance. These areas are determined, mapped, and conditions set to protect these areas as part of the Section 248 process. The permit conditions set in the 248 process to protect the RINA are typically required to be followed for in perpetuity while the facility is still under 248 jurisdiction. Areas designated as RINA and conditioned for protection many years ago still need to be protected and conditions followed each time maintenance or other work needs to occur. Therefore, any work that needs to occur with a designated RINA must be reviewed by the Environmental Team prior to starting work.

### **DEER WINTERING AREAS**

Deer in Vermont live near the northern limit of white-tailed deer range in eastern North America. This forces deer to use very specific winter habitat when severe climatic conditions become a threat to the animals' survival. Areas that are used year after year by deer seeking winter shelter are called deer

wintering areas or deer yards. Since only about 6% of Vermont's land base is deer wintering area, the ability to recognize and manage these critical habitats is necessary to ensure the future well-being of the state's deer herd. The primary goal of deer wintering area management is the promotion of softwoods.

Physical evidence of use by deer is the best way to determine whether an area can be considered a deer wintering area. The most obvious indications of very recent deer use include tracks, trails and droppings. Other less obvious, though more reliable, indicators of deer wintering area are the more permanent signs of deer use on vegetation, such as browsing and bark scarring. Known deer wintering yards are mapped and classified by the State and shown on the VELCO environmental resource maps, project plans (where applicable), and the VTANR Atlas. Impacts to deer wintering areas are categorized as direct and indirect where:

- Direct impacts involve the removal of trees, or creating impasses to travel corridors/habitat.
- Indirect impacts involve increased human activity in habitat.

Any activities found to have direct impact on deer wintering yards will need to be discussed with the Environmental Team. Direct impacts require mitigation compensation and may require permitting efforts. Time of year considerations should be taken into account when planning Work. Work within or near deer wintering areas should be performed outside of the winter timeframe, generally December 15 to April 15.

Indirect impacts to Deer Wintering Areas associated with transmission line construction and maintenance are temporary and should have little effect. Indirect impacts may need to be evaluated further for development sites such as laydown yards, substations, other new facilities or for activities that require prolonged timeframes within or adjacent to deer wintering areas.

Regular maintenance work within the ROW is allowable; work outside of ROW that results in a reduction in canopy cover needs to be reviewed by VELCO Environmental prior to Work commencing.

## BLACK BEAR HABITAT

The best habitat for black bears in Vermont is a mixture of coniferous trees, hardwoods, wetlands, and variation in terrain. Because they need dense cover to escape danger, the wary and elusive black bears prefer rough and wooded habitats. Bear habitat is mapped and classified by the State and shown on the VELCO environmental maps, project plans and maps, and the VTANR Atlas. Impacts are categorized as direct and indirect where:

- Direct impacts involve the removal of trees, particularly bear scarred beech stands or creating impasses to travel corridors.
- Indirect impacts involve increased human activity in habitat.

For transmission line work in mapped habitat, consult with the Environmental Team. Regular maintenance work within the ROW is allowable, though work that requires tree cutting, new access roads, or off-ROW activities need to be approved by VELCO Environmental.

## OSPREY

Osprey populations in Vermont have been on the rise since 1992, causing an increase in interactions with electric utilities. Once listed and protected as an Endangered species, the osprey was removed from listing status in 2005 due increasing population numbers, which is attributed to EPA's ban on DDT (an

herbicide used heavily in the 1950s and 60s) and successful habitat restoration efforts including the establishment of nesting platforms. Osprey are still federally protected under the Migratory Bird Treaty Act (MBTA), which prohibits nest management activities (whether active or inactive) during the nesting period of April 1 - August 31 without consultation and necessary approvals. VELCO recognizes there are many other species protected under the MBTA; all project reviews consider migratory birds and account for adequate protections. Ospreys are the most encountered on VELCO infrastructure.

As part of VELCO's commitment to environmental stewardship and system reliability requirements, VELCO has been involved with protecting and creating safe osprey nest platforms since the early 1990s. Ospreys prefer the tall sturdy structures that support Vermont's electric grid, but nests built on electric transmission structures can pose an outage and fire risk, as well as a threat of electrocution of the birds. To prevent this, VELCO crews have constructed and maintained successful nesting platforms across the state for over thirty years.

Anytime osprey nesting activities pose a risk to the electric grid, the VELCO Environmental Team should be notified. VELCO Environmental will work to ensure alignment with the MBTA and to evaluate suitable nesting alternatives. If the nest poses an imminent threat to the system it will be removed immediately, and VELCO Environmental will notify appropriate agencies.

When dealing with an osprey nest on VELCO infrastructure the following should be assessed:

- Has the nest been fully established or is it a collection of sticks in an attempt to build a nest?
  - Incomplete nests can be removed; however, osprey are persistent and will most likely return to that same structure to start their nest over again without the installation of physical deterrents and a nearby alternative nesting platform (which must be equally attractive in terms of height and proximity to open water).
- If the nest is fully established and occupied, i.e. are there eggs or young birds in the nest?
  - If there are eggs or young in the nest, further consultation will be required.
  - When necessary, a certified VELCO drone pilot may assist with a non-invasive inspection.
- Does the nest need to be removed from the structure or can it be temporarily shifted or moved to reduce the risk to VELCO infrastructure until the young have fledged the nest?
  - This is the preferred management method if there are eggs in the nest.
- If the nest needs to be relocated, is there a nearby existing structure capable of supporting the nest? If there is no existing, suitable structure available in the immediate vicinity, can crews reasonably install a new nesting platform at the structure or on a nearby structure?
  - If the nest is moved on the structure, it should be re-evaluated after the birds have fledged the nest (typically by September) for relocation onto a designated platform attached either to the structure or away from VELCO infrastructure.
- In all nest removal cases, physical deterrents should be installed on the structure to prevent the ospreys from returning. To achieve the most success, platforms and deterrents should be used together.

It is VELCO's preference to install osprey nesting platforms in sensible locations away from VELCO infrastructure, thereby reducing the risk to the electric grid as well as promoting the safe nesting and reproduction of a once endangered species.



## GRASSLAND BIRDS

Grassland birds are specialists, dependent on grassland habitats to successfully forage, roost, and raise young. In Vermont, grassland habitat has declined significantly; the majority of the current landscape is forested. The small percentage of Vermont's land area that constitutes grassland habitat is hay fields, pastures, fallow fields, beaver meadows, and native prairies. Although natural forces such as flooding can create and maintain grassland habitat, most of the habitat that exists today is the result of agricultural practices.

Grassland habitat is considered as "necessary wildlife habitat" for all species of grassland birds in Vermont. VTANR defines grassland bird habitat as a field that:

- consists of greater than 20 acres,
- is sufficiently open to attract and retain nesting grassland birds,
- is vegetated primarily with grasses,
- contains little to no woody vegetation, and
- has any of the following species present during their breeding season (approximately May 1 through July 31): bobolink, savannah sparrow, eastern meadowlark, grasshopper sparrow, upland sandpiper, or vesper sparrow.

In Vermont, common grassland birds include the bobolink, meadowlark, savannah sparrow, and northern harrier (marsh hawk). Bobolink's habitat requirements best overlap those of other grassland bird species in Vermont and, as such, bobolink's presence at a particular site is used as an indicator of suitable grassland bird habitat. Bobolinks prefer to nest in grasslands with vegetation that reaches a medium to tall height (e.g., uncut hay and alfalfa) and few to no tall trees or other vertical structure within roughly 164 feet (50 meters) depending on topography.

VELCO's properties and easement lands may contain or be adjacent to grassland bird habitat, which should be evaluated for potential impact considerations as part of the site selection and project design process. The following BMPs should be followed:

- Avoid impacts to grassland bird habitat, if possible.
- When possible, avoid Work activities within grassland bird habitat during grassland bird breeding season of May 1 - August 1.
- Minimize unavoidable impacts to grassland bird habitat by adjusting access design of the project, such as access routing and crane pad siting.
- As part of site restoration in grassland bird habitat, crews should ensure the area is brought back to existing grade and, where necessary, seeded with a suitable seed mix to ensure herbaceous cover.

## PRIME AGRICULTURAL SOILS

Prime and/or Statewide Agricultural Soils (PAS) are an important farmland soils map unit that the Natural Resources Conservation Service of the U.S. Department of Agriculture (NRCS) has identified and determined to have a rating of prime, statewide, or local importance. PAS are protected in the State of Vermont through its Land Use regulations (Act 250 and Section 248). Essentially, these are soils in a

large enough area that have the potential to be farmed. PAS are identified on the VELCO Environmental geodatabase, project plans, and/or the VTANR Atlas.

Work in these areas should not significantly interfere or jeopardize the continuation of agriculture or forestry on adjoining lands other than primary agricultural soils owned or controlled by the applicant which are reasonably suited to the purpose of the development or subdivision.

## Avoidance and Minimization

If possible, the preference is to avoid Work in PAS areas. If Work must occur in mapped PAS, Work shall be conducted using the following BMPs (in order of preference):

1. Avoid impacts by siting work activities outside of mapped PAS.
2. Avoid/minimize disturbance by using existing travel lanes.
3. Perform work during dry or frozen conditions.
4. Avoid crop damage with the timing of work activities.
5. Utilize construction matting or low impact equipment to avoid soil compaction and/or rutting.

## Working in PAS

For impacts that involve excavation, crews should excavate, stockpile and replace the PAS separately by each clear break in soil horizon for each apparent soil type following installation. Crews should restore the area to pre-existing contours, such that the level of soil in the work area is the same as prior to disturbance. In order to maintain consistent pre- and post- installation site grades, excess subsoil will be removed from the excavation and reused on site or disposed of in accordance with VTANR regulations.

For impacts related to potential soil compaction, crews performing overland travel should utilize low impact equipment, minimize vehicular/equipment trips, and avoid wet and/or muddy areas. In areas where heavy equipment access is required and soil compaction is unavoidable, temporary construction matting or the temporary installation of 6" or more of stone atop of geotextile fabric can be utilized to provide a stable road or work surface for the duration of the project. Following construction, any substantially compacted areas should be subsoiled or tilled, as appropriate, and all grades should be leveled to eliminate the potential for ponding and erosion issues.

To ensure that operations and maintenance and/or construction materials will not interfere with use of the land for agricultural activities, unused and retired materials should be removed from the work site and reused, recycled, or disposed of as appropriate and in accordance with this document and all applicable regulations. Similarly, flagging materials such as metal pin flags, should be avoided whenever possible and if necessary, only be installed/used in active agricultural fields when required and should be removed as soon as reasonable possible (i.e. wetland delineation flagging to be removed once GPS point data has been collected). If pin flagging is required care must be taken to remove **ALL** pin flags.

Crews should ensure the successful revegetation of all areas affected by Work activities as part of final restoration. PAS areas may warrant special seedbed preparation measures such as subsoiling, discing, and/or tilling to support revegetation. The Environmental Inspector/s and Access Coordinator/s should evaluate soil conditions throughout the duration of the Work and, where necessary, implement seedbed preparations as part of the final restoration effort.

Impacts to PAS areas associated with development of substations or other facilities are reviewed through the Section 248 or Act 250 process and may require additional mitigation measures for project approval.

Regular maintenance work within areas of PAS in the maintained ROW is allowable. Work that requires stumping and grubbing, the construction of new access roads, and/or off-ROW activities need to be reviewed by VELCO Environmental prior to the Work occurring.

## DRINKING WATER PROTECTION

The VELCO Environmental geodatabase or project plans (where applicable) identify known wells and drinking water source protection areas. Drinking water supplies and Work within the 50-foot buffer or within source protection areas should be avoided to the extent feasible. For work within well buffers or within source protection areas, the following guidelines should be implemented:

1. Consult VELCO Environmental Team prior to earth disturbing activities.
2. All Work should avoid impacts to the drink water supply.
3. Earth disturbing activities within the 50-foot buffer or within drinking water protection areas should be minimized by using construction mats or placing fabric and stone directly on vegetation in upland areas.
4. If poles are to be replaced in a drinking water protection area or within the 50-foot buffer of a shallow drinking water supply well, Penta BMPs (see attachment [Docket 8310 Appendix 1](#)) must be followed and treated wood poles should be replaced with an alternative pole material (i.e. steel poles) whenever possible.

For herbicide use proximate to drinking water supply areas, refer to VELCO's Transmission Vegetation Management Plan.

## ARCHAEOLOGY

Due to the linear nature, remote locations, and access constraints of the VELCO system, cultural resources are often encountered and traversed by construction and maintenance equipment. Oftentimes cultural resources are buried underground and/or invisible to the untrained eye, but they still must be protected to ensure their preservation. Best Management Practices (BMPs) shall be used to avoid, protect, and minimize impacts to cultural resources.

Some types of Work conducted by or on behalf of VELCO have been previously determined to not require archaeological survey/monitoring or prior notification to the Vermont State Historic Preservation Office (SHPO). These activities include:

- Use of existing access routes for work site access, including but not limited to, farm roads and logging roads.
- Pre-construction activities, including, but not limited to, wetland delineations, civil surveys, and site demarcation.
- Installation, maintenance, and removal of Erosion Prevention, and Sediment Control (EPSC) measures, use of temporary bridges and maintenance of existing stormwater conveyance

structures.

- All activities in areas deemed to be culturally/archaeologically non-sensitive by the GIS-based predictive model and/or a qualified archaeologist.
- Post-construction landscape plantings for aesthetic mitigation in residential settings.
- Activities not involving ground disturbance.

## ARCHAEOLOGICAL BMPS

The BMPs included in this section are designed for implementation during access or line construction, maintenance, and vegetation management activities to proactively protect cultural resources while maintaining VELCO's capability to ensure the safe, reliable, and cost-effective delivery of electricity. These BMPs are a component of VELCO's commitment to comply with relevant state and federal authorities regarding cultural resources, such as professional standards and requirements established by the SHPO, Vermont Public Utility Commission Section 248 filings, and National Historic Preservation Act of 1966, as amended.

### Data Management

There are a variety of cultural resource datasets throughout Vermont and on the VELCO transmission system. Datasets include:

- Digitized cultural resource areas from the State of Vermont Department for Historic Preservation.
- GPS surveyed cultural resource areas from past archaeological investigations by VELCO or other entities.
- Predictive model based on Vermont's [Predictive Model for Locating Precontact Archaeological Sites](#). Data used in the model include: natural resource data, two-foot contours, available cultural resource data and various publicly available datasets.

Recognizing the disadvantage of multiple, disjointed datasets, VELCO has created a comprehensive master dataset that incorporates all the best available cultural resource datasets into one spatially-based geodatabase. The data is managed by the Environmental Team and is regularly updated. The master VELCO cultural dataset is managed via GIS mapping software available on both field and desktop devices for construction, maintenance, and vegetation management/ROW crews. The data is considered to be confidential and any information regarding archaeological sites and their location should not be shared outside of the company or its consultants.

### Site Identification

Prior to conducting construction or maintenance activities, VELCO will identify known cultural resource areas. Areas where cultural resource information is not known will be evaluated utilizing VELCO's GIS mapping tool based on Vermont's *Predictive Model for Locating Precontact Archaeological Sites* to identify areas potentially containing cultural resources. The results of the GIS-based predictive model may be evaluated further by a qualified archaeologist/s on a site-by-site basis. Further evaluation could include confirmation or dismissal of areas potentially containing cultural resources by a qualified archaeologist, which may include on-site reconnaissance.

Based on the needs of the construction and/or maintenance activities, identified cultural resource areas will be further evaluated to determine appropriate steps to avoid the area/s or, if avoidance is not possible, when to perform subsurface archaeological testing. If subsurface archaeological testing is required, the survey methods shall conform to the SHPO's [Guidelines for Conducting Archeology in Vermont](#), which will be conducted by a professional archaeologist. If no archaeological sites are identified during subsurface testing, the assessment area is considered not to contain cultural resources. If an archaeological site or sites are identified, site avoidance and protection measures outlined below will be followed.

Applicable areas of identified or potential cultural resources shall be depicted on all project plans.

## Site Avoidance

The greatest protection for cultural resources is avoidance. Cultural resources will be avoided to the greatest extent possible during planning, construction, and maintenance activities. In the planning stages special consideration should be taken to place new structures, new access roads, wire pulling boxes, and other work areas outside of cultural resources. All available data will be captured and depicted in a common location, such as a set of Project Plans, to allow required parties to work together to develop a plan that avoids or minimizes impacts to cultural resources.

## Site Protection and Minimize Risk of Impacts

In addition to the site identification measures listed above, the following BMPs will be considered and implemented, as needed, to minimize potential soil disturbing activities including soil shearing, compaction, and overall soil disturbance that may cause impacts to cultural resources.

### *Flagging and Barrier Tape*

Labeling of resource areas may be required in the field in addition to identification on project plans. Protection of cultural resources both in and outside of the VELCO work area may be identified and marked with one or more of the following: signage, site flagging, barrier tape, and/or snow fence. This helps prevent disturbance and intrusion into the cultural resource area. See the [Flagging](#) section above for standard VELCO flagging colors and patterns for protected resources.

### *Access, Construction Matting and Equipment Pads*

If access into a cultural resource area is required for Work, appropriate care shall be taken to protect the resource. Equipment access via overland travel should utilize existing routes of travel within or adjacent to the ROW. Improvements (such as resurfacing or grading) of existing roads that do not expand the footprint are permitted. Access will be performed under suitable ground conditions to prevent and/or limit soil disturbance, rutting, and compaction of soils, providing protection of the below ground cultural resource/s. The number of vehicular trips through or within the identified cultural resource areas will be minimized whenever possible. The turning of equipment shall be kept to a minimum. Low impact equipment, typically tracked equipment, will be utilized when overland travel is necessary to conduct the Work.

If access would result in significant rutting or ground disturbance, construction matting will be used to prevent potential impacts to the resource. Installation of construction matting will be performed in a manner, which minimizes soil disturbance and compaction. Mats shall be installed

and removed sequentially, where the equipment installing or removing the mats continually works/accesses atop other construction mats. Mats shall be set into place. Dropping or dragging of mats within an identified cultural resource site will be avoided. Brush matting and/or woodchips may be utilized to construct temporary access roads on suitable soils where the use of construction matting is not feasible.

Equipment pads within identified or potential cultural resource areas should be constructed with construction matting and limit soil disturbance to protect the resource. Earthen equipment pads may be constructed if they are located outside of any identified cultural resource. Suitable erosion controls will be employed during equipment pad building to allow for soil stabilization, minimize runoff, and thereby protecting the resource from erosion and/or sediment deposition. In some cases where construction matting is not feasible, encapsulation of the resource may be an option. Encapsulating a cultural resource must be conducted in consultation with the USACE and/or the SHPO.

### ***Pole and Structure Setting***

Poles and structures to be set in identified cultural resource areas will be installed with an auger device whenever possible to limit the extent of ground disturbance in the site. Pole replacements will be set within the existing pole hole, or as close to the existing pole or structure as possible to limit disturbance in the site. Pole installations or replacements that cannot utilize an auger device or cannot be installed within 8' from the existing structure will need additional review by a qualified archaeologist and possible consultation with the USACE and/or the SHPO. Suitable erosion controls will be employed during pole and structure setting to allow for soil stabilization, minimize runoff, and protection of resources.

### ***Guy Anchor Installations***

Helical (screw) anchors or tipping-plate anchors shall be installed in identified cultural resource locations when conditions permit. This practice will provide protection to the site by limiting soil disturbing activities. In identified cultural resource areas where helical and tipping-plate anchors cannot be utilized and log anchors may be required consult the VELCO Environmental Team before proceeding. In identified cultural resource areas with shallow ledge or bedrock, drilled rock anchors may be installed. Suitable erosion controls will be employed during anchor installation efforts to maintain soil stabilization, minimize runoff, and protect resources.

### ***Vegetation Management***

Maintenance of the transmission line ROW with equipment within identified cultural resource areas shall be accomplished by utilizing low impact equipment, in suitable conditions or atop existing access routes. Construction matting shall be utilized where mechanized clearing and maintenance activities must be performed and ground conditions prohibit overland travel. Equipment access utilizing overland travel should utilize existing routes of travel within or adjacent to the ROW where possible. Brush matting and woodchips may be utilized to construct temporary access roads but require review and approval by the Environmental Team.

Tree removal will not result in significant ground or soil disturbance. No stumping or grubbing will be conducted within the boundaries of an identified cultural resource area.

### ***Alternate Operation and Maintenance Practices***

In some instances, it may become necessary to devise alternative practices than what is outlined

in this document. If alternative work practices are required, VELCO Environmental shall develop a work plan for a location- or project-specific BMPs and consult with a qualified archaeologist and, if appropriate, the USACE and/or the SHPO for concurrence prior to conducting the activity. This work plan may include:

- A summary as to why the alternate BMPs are required.
- A comparison of the proposed alternate approach to the existing BMPs.
- Documentation of previous use of the proposed alternate BMPs that illustrates appropriateness.
- Specifications detailing the proposed alternate BMPs.

## EMERGENCY RESPONSE BMPS

VELCO occasionally must respond to emergencies on the transmission system, such as storm damage, impaired facilities, or removal of hazard trees, which require immediate response for optimal electric transmission reliability and safety. If emergency work is required within an identified cultural resource area, the VELCO Environmental Team shall be consulted and will review the available GIS/GPS data in the work area and areas of access to provide guidance to staff on the work to be performed. If appropriate, VELCO will provide notification to the USACE and the SHPO if identified cultural resources are impacted. During declared states of emergency, prescribed guidelines or emergency-specific guidance will be followed.

## UNANTICIPATED DISCOVERY OF CULTURAL RESOURCES

Although most project areas have been assessed for the presence of cultural resources as well as other protected resources in advance of work, numerous variables during construction could potentially reveal previously unidentified or unexpected resources. Resources may include buried artifacts, alignments of stone with one or more right corners, depressions lined with stone or brick or human remains.

In accordance with SHPO guidance, the following procedure is to be followed:

1. The project will immediately stop all work at that location if previously unidentified cultural resources are discovered during construction or maintenance activities.
2. The Environmental Team shall perform a site inspection with construction personnel to discuss avoidance measures.
3. If the archaeological feature is avoidable, the area will be flagged with barrier tape or similar protective measure.
4. If the archaeological feature cannot be avoided, the inspector will perform a review to determine if the area was previously assessed. If the inspector determines that the area was not previously assessed, work will be discontinued until an assessment can be conducted.
5. A qualified archaeologist may be consulted on the items discovered. Following the archaeologist's review, any further field assessment and agency notifications (e.g., USACE and/or SHPO) will be made depending on the findings from the assessment.
6. Depending on the statutory jurisdiction of a project (e.g., state or federal law) or when a landowner is a state or federal agency, additional agencies may need to be notified to resolve the



matter in accordance with their respective authorities. One or more of these agencies may request the development of a treatment plan.

7. If human remains are discovered, the following procedures are in effect:
  - a. All work at the location must stop immediately.
  - b. The remains will be respectfully covered, and the VELCO Management Team will be immediately notified of the discovery.
  - c. Procedures will be followed that are consistent with 18 VSA § 5212: “Unmarked burial sites special find; reporting of unmarked burial sites.” When an unmarked burial site is first discovered, the discovery shall be reported immediately to the appropriate law enforcement agency.
  - d. If, after completion of an investigation, a law enforcement agency determines that the burial site does not constitute evidence of a crime, the law enforcement agency shall immediately notify the Vermont State Archaeologist who may authorize appropriate action regarding the unmarked burial site. These actions may include additional archaeological or non-intrusive survey of the location or other measures to protect, preserve, move, or reinter unmarked burial sites and human remains.
  - e. Subsequent activities will proceed only after consultation between VELCO and the Vermont State Archaeologist as to next steps for addressing the find. These steps may include, but are not limited to, the previously defined BMPs for [Site Avoidance](#) and [Site Protection](#).

## **SUMMARY**

VELCO strives to be a leader of environmental sustainability and conservation. The work practices, guidance, and BMPs contained within this document outline VELCO’s approach to environmental stewardship and compliance. If there are any questions or if you would like more information on the topics within this document please [contact](#) the VELCO Environmental Team.

To view the VELCO Environmental Sustainability Policy, please visit our website at: <https://www.velco.com/our-work/environment/enviropolicy>.



		<b>ENVIRONMENTAL CHANGE REVIEW FORM</b> Change No.:	
Requester:		Date:	
Project Location (e.g. structure #., substation)		Project Name:	Work Order No.
Reason for Change (circle all that apply)			
Construction	Environmental Team	Legal	Design
Landowner/ROW	Landowner	Other	
Type of Change (circle all that apply)			
Structure Type	Landscaping	Site Plan/Limit of Disturbance	Access Road
Structure Location	Tree Clearing	Subterranean	Substation Equipment
Other			
Description (to be completed by Requestor – add additional sheets/drawings as necessary):			
<b>Environmental Team Review (attach Env. Change Review Form):</b> NOTES (provide comments/status on actions necessary before change can be approved) :			
Resource Evaluation (circle when resource has been evaluated – use back of form for additional commentary)			
Archeology	RTE/RINA	Ditch/Stream/River	Other
Wetland	EPSC/CGP	VTRANS/Railroad/FAA	
Drawing Updates Required: (circle all that apply)			
Plan & Profile	Landscape Mitigation	Compliance Plans	Plan Book Amendment      Other
Required Submittals/Actions (if none, circle and insert NA)			
DPS	PSB	DPS/PSB	OTHER
Notes: (provide additional comments/instructions/conditions of approval:			
<b>APPROVALS</b>			
REQUESTOR		CONSTRUCTION MANAGER	
PRINTED NAME	SIGNATURE	DATE	PRINTED NAME      SIGNATURE      DATE
COMPLIANCE LEAD		PROJECT MANAGER	
PRINTED NAME	SIGNATURE	DATE	PRINTED NAME      SIGNATURE      DATE
ENVIRONMENTAL TEAM LEAD			
PRINTED NAME	SIGNATURE	DATE	
Procedure: 1. This form is to be used by the Env. Team to ensure that protected resources are properly evaluated, and if necessary, permits and; compliance plans are amended, before changes are executed in the field. 2. A change shall not be approved until this form is signed by the Environmental Team Lead, and f necessary the CM and PM, and a copy returned to the Requestor. 3. Construction and Project Manager signatures required for all permit amendment submittals.			
Form Rev. 4.0 11/11			



**VELCO ENVIRONMENTAL INCIDENT REPORT FORM**

Project:

Date/Day/Time:

Weather Conditions:

Location (Structure#)

On-site Personnel:

Description of Incident (include description of resource area (wetlands, etc.) :

Necessary Corrective Actions (by Whom/Date/Time):

VELCO Contacts Made (by Whom/Date/Time):

Follow-up Field Inspection (by Whom/Date/Time):

Additional Corrective Actions (by Whom/Date/Time):

**Conveyance & General Release Agreement**

**Between**

**Vermont Transco LLC,**

**And**

---

**[ENTITY OR PERSON REQUESTING POLES]**

---

This Conveyance & General Release Agreement (the “Agreement”), dated \_\_\_\_\_, 20\_\_ is made by and between **VERMONT ELECTRIC POWER COMPANY, INC.**, a Vermont corporation with its principal place of business in Rutland, Vermont and **VERMONT TRANSCO LLC**, a Vermont limited liability company with its place of business in Rutland, Vermont (collectively “VELCO”) and \_\_\_\_\_ (“Recipient”) of \_\_\_\_\_, Vermont.

WHEREAS: Recipient desires to take, own, utilize, transport, and eventually dispose of certain wooden poles (“Pole Structures”) previously used in the transmission of electricity by VELCO on Line \_\_\_\_\_; and

WHEREAS: VELCO agrees to convey title, if any, ownership, if any, and possession of one or more Pole Structures in exchange for Recipient’s acceptance of sole responsibility for the transportation of the Pole Structures from their respective locations in situ; a complete release and general waiver of all present and future liability for the Pole Structures; and full indemnity for any and all resultant damage said Recipient may experience after title to the Pole Structures vests in Recipient.

NOW THEREFORE, in consideration of the mutual covenants and agreements herein set forth, and the non-cash consideration paid pursuant hereto, and intending to be legally bound, the parties hereby agree as follows:

Recipient agrees that upon pick-up or possession, title will transfer to Recipient, and VELCO will have no further responsibility, liability, or other duty related to the Pole Structures, nor is any representation made with regard to the existence of any deficiencies or status of integrity. Recipient explicitly acknowledges that it waives any and all claims, suits, demands, or other rights whatsoever, that it may have had, or in the future may have, against VELCO, any or all of its affiliates, directors, officers, employees, agents, and assigns, with regard to the Pole Structures.

Recipient expressly acknowledges that the poles may have been chemically treated and takes possession with full risk thereof, and agrees that the poles are not intended for use in playgrounds or other structures intended for use by children, and are not intended for use in applications involving livestock feed.

VELCO HEREBY DISCLAIMS ANY AND ALL WARRANTIES, EXPRESS OR IMPLIED, INCLUDING BUT NOT LIMITED TO, IMPLIED WARRANTIES OF MERCHANTABILITY OR FITNESS FOR ANY PARTICULAR PURPOSE. THE POLE STRUCTURES TRANSFERRED HEREUNDER ARE TAKEN AT THE SOLE RISK OF THE RECIPIENT AND ARE CONVEYED AND ACCEPTED “AS IS, WHERE IS” AND “WITH ALL FAULTS.”

If this Agreement is subject to the approval of any regulatory body, including but not limited to state or federal environmental permitting, Recipient agrees to make the appropriate filings with such regulators following execution and delivery of this Agreement. Recipient further agrees to obtain all applicable permits and approvals as may be required by any governmental authorities or third-persons with an interest in the conveyance of the Pole Structures.

Recipient hereby agrees to indemnify and hold harmless VELCO, any or all of its affiliates, directors, officers, employees, agents, and assigns, from any and all third-party claims, causes of action, suits, losses, demands and damages related to any and all liability resulting or arising from this Agreement or the conveyed Pole Structures. Recipient is responsible for all liability, consequence, loss or damage that may result after taking title to any Pole Structure, not to be limited to foreseeable potential liability or damages.

This Agreement is subject to the law of the State of Vermont, notwithstanding conflicts of law principles.

This Agreement is effective as of the date first written above.

**Vermont Transco LLC**

\_\_\_\_\_

Name

\_\_\_\_\_

Title:

**Recipient**

**Environmental Fact Sheet #WM-1001  
“Managing Treated Wood Waste”**

\_\_\_\_\_

Name

\_\_\_\_\_ was provided

\_\_\_\_\_

Address

# Environmental Fact Sheet



DEPARTMENT OF ENVIRONMENTAL CONSERVATION

Rev 8/2015

## Managing Treated Wood Waste

Wood products such as utility poles, railroad ties, and lumber for outdoor exposures are treated with chemical preservatives that create a barrier against insect attack and decay. These wood products can contain toxic constituents in sufficient concentrations to constitute a threat to public health and the environment if improperly reused, or cause the products to be regulated as hazardous waste when discarded. This Fact Sheet is intended to describe best management practices for treated wood reuse and allowable disposal options. As described below, treated wood waste disposal by businesses may be subject to regulation as a hazardous waste.

Wood preservatives fall into three broad categories which, in turn, dictate how the treated wood should be managed when removed from its original use. The categories are:

**Water-borne preservatives:** The most common water-borne preservatives used to treat wood include *Chromated Copper Arsenate (CCA)*, *Ammoniacal Copper Quat (ACQ)*, *Ammoniacal Copper Zinc Arsenate (ACZA)*, as well as the less-toxic, inorganic borate compounds. Wood treated with waterborne preservatives is used in a variety of outdoor residential, commercial, and industrial products and applications, such as decking and walkways, fences, gazebos, docks, playground equipment, highway noise barriers, utility poles and retaining walls. CCA treated wood is no longer available for residential use.

**Creosote-treated wood:** Wood treated with creosote is used mainly for bridge timbers, railroad ties, retaining walls, and docks.

**Oil-borne preservatives:** Common varieties of oil-borne preservatives include chlorophenolic compounds, e.g., pentachlorophenol, or “penta,” and copper naphthenate. “Penta” is the most widely used oil-borne preservative, used to preserve utility poles and cross arms, railroad ties, and fence posts. Neither penta-containing products nor wood treated with penta are available for residential use.

As a general rule, treated wood is easy to recognize. Wood that is treated with creosote or chlorophenolic compounds tends to be dark in color and has a “chemical” or “smoky” odor. Wood that is treated with water-borne inorganic preservatives can usually be identified by a characteristic “greenish” color.

### How can treated wood be reused?

The Waste Management and Prevention Division (WMPD) does not consider wood treated with water-borne preservatives or creosote to be waste when reused appropriately, i.e., reused in a manner that does not pose an increased risk to human health or the environment. In general, “appropriate reuse” of these types of treated woods does not increase the amount of surface

area available to leaching, involve placement in or near environmentally sensitive areas, or involve combustion of any type. Some examples of appropriate reuses include:

- ✓ use as support beams in open-air construction; and
- ✓ use for general landscaping in areas that are not in the vicinity of food crops (e.g., terracing, fencing, property line demarcation).

**Because of the greater toxicity of the preservative, and increased potential for environmental harm if misused, the WMPD discourages the reuse of chlorophenolic treated wood, except by the original owner. If these products are considered for reuse, the WMPD strongly recommends that the original owner provide the recipient with this Fact Sheet, and obtain a signed consent form indicating that the recipient understands the risk associated with the product, best management practices for the product’s reuse, and end-of-life disposal options.**

**How can treated wood waste be disposed of when it is not reused?**

Household-generated waste is categorically exempt from regulation as hazardous waste; therefore, treated wood waste generated from a household may be disposed of at a lined, solid waste landfill.

**Business-generated treated wood waste that is not reused by the original owner, must be evaluated to determine if it is hazardous waste. Waste that is determined to be hazardous must be managed in accordance with the Vermont Hazardous Waste Management Regulations.** The owner or operator of a business can determine whether or not treated wood is hazardous waste based on either “generator knowledge” about the wood, or laboratory analysis.

Treated wood waste is considered hazardous waste when certain contaminants are present at or above specified limits. The test method used to make this determination (when the determination is not based on “generator knowledge”) is the Toxicity Characteristic Leaching Procedure, or TCLP. The regulatory levels for the contaminants generally associated with treated wood are specified in the following chart:

Types of Treated Wood / Distinguishing Characteristics	Hazardous Waste Number	Contaminant	Regulatory Level (mg/L)
<b>Inorganic Preservatives:</b> "greenish" in color.	D004	Arsenic	5.0
	D007	Chromium	5.0
<b>Creosote Formulation:</b> brown to dark brown in color; may be coated with tar; has a "smoky", chemical odor.	D023	o-Cresol	200.0 <sup>1</sup>
	D024	m-Cresol	200.0 <sup>1</sup>
	D025	p-Cresol	200.0 <sup>1</sup>
	D026	Cresol	200.0 <sup>1</sup>
<b>Chlorophenolic Formulations:</b> Similar characteristics to creosote.	D037	Pentachlorophenol	100.0

<sup>1</sup> If o-, m-, and p-Cresol concentrations cannot be differentiated, the total cresol (D026) concentration is used. The regulatory level of total cresol is 200.0 mg/l.

Treated wood that is not subject to regulation as a hazardous waste, i.e., treated wood from businesses that does not exhibit the toxicity characteristic and is therefore non-hazardous, may be disposed of in certified, lined landfills. (Analogous to household-generated treated wood.) Treated wood should not be shredded or ground prior to disposal.

Note that treated wood (hazardous waste or not) cannot be burned for either energy recovery or disposal unless it is burned in a device that has been permitted by the Agency for that purpose.

**For Addition Information About...**

...burning wastes, contact the **Air Pollution Control Division** at (802) 828-1288.

...this fact sheet, or other solid or hazardous waste management issues, contact the **Waste Management And Prevention Division** at (802) 828-1138, or visit the Division web site  
<http://www.anr.state.vt.us/dec/wastediv/index.htm>

...reducing the amount, and the toxicity, of waste produced, contact Vermont's non-regulatory **Environmental Assistance Office** toll-free (in Vermont) at 1-800-974-9559.



**Appendix 1****Best Management Practices (BMPs) Associated with the Use of Pentachlorophenol-treated Utility Poles in Vermont****Procurement, Delivery & Storage**

1. Require Traceable ID brand with plant location and year produced, which can be traced to the batch of treated poles.
2. Require all poles used in VT to be treated to AWWA specifications for deterioration zone 2.
3. Require all poles used in VT to be double vacuum treated or extend vacuum cycle to twice the standard length prior to delivery to VT. In some cases, utilities may require immediate delivery of poles for emergency restoration activities, and that such poles may deviate from normal specifications. However, in all cases, reasonable efforts will be made to install poles in accordance with these BMPs.
4. Inspect poles on delivery – Retain the right to reject any pole that exhibits excessive sweating of preservative solution. This is more readily accomplished during the warmer months.

**Permanent Pole Storage Areas Use for design of new construction or substantial reconstruction of existing pole storage areas**

1. Locate 100 feet from drinking water sources and as far away as possible from residences.
  - a. Design considerations should include:
    - i. A low permeability surface material (compacted soil or asphalt) with absorbent/organic material; or
    - ii. Other containment/migration prevention measures
2. Poles should be elevated off ground surface
3. Ground surface should consist of a low erosion potential substance
4. Maintain a yard slope of less than 10% throughout the pole storage area
5. Pole storage areas should be sited to limit odor impact to the public
6. Pole storage areas should be visually inspected when work is being done at a pole yard for excessively sweating poles, unusual staining, or other evidence of unusual releases of pentachlorophenol.

**Pole Siting & Construction**

1. Onsite utility personnel and contractors should inspect all poles prior to installation to ensure no excessive release of preservative solution is occurring
2. Before installing any new pole, determine if there are any shallow drinking water sources within 50 feet of the pole location. Wherever feasible poles should be located at least 50 feet away from shallow drinking water sources; if this is not feasible utilities should, in the following order;
  - a. Use an alternative type of treated pole
  - b. Use a containment structure or barrier (e.g., pole sleeve)
  - c. Work with landowner(s) to develop a proactive plan to prevent contamination to the drinking water supply. Also provide landowner ANR fact sheet, *What to Do If You Suspect Drinking Water Contamination from Utility Poles*

**Decommissioning, Retirement, and Disposal of Pentachlorophenol-treated Poles**

1. Removal of poles (based on specific site characteristics)
  - a. Cut pole and leave butt in ground: appropriate in remote locations and sensitive areas (e.g., wetlands) where access by construction vehicles is difficult or unsafe, or poses significant environmental risk, including soil erosion
  - b. Pull pole butt and replace with clean fill, where appropriate: appropriate in locations accessible by construction equipment or where the utility or landowner determines that cutting the pole would pose an unacceptable risk of injury after the pole butt decays
  - c. If excavation is required to remove the pole, limit soil disturbance to the extent possible and implement soil management, and erosion and sediment control measures. Excavation should be delayed when

there are extreme weather conditions which may lead to erosion (high sustained wind, heavy precipitation) and are within 50 feet of a drinking water well.

- d. For work within 50 feet of a shallow drinking water source, excavated soil should be removed and disposed of in accordance with Vermont solid waste regulations.
  - e. Grossly contaminated soil should be removed and disposed of in accordance with Vermont solid waste regulations.
2. Reuse pentachlorophenol-treated wood poles consistently with the restrictions placed on the original product.
    - a. Provide ANR fact sheet "Managing Treated Wood Waste" to all private parties that accept decommissioned poles for reuse.
    - b. If reuse is not feasible, dispose of treated poles in accordance with all applicable ANR regulations

### Training/Education

1. In order to ensure compliance with these BMPs train appropriate personnel to:
  - a. Locate and identify shallow drinking water sources
  - b. Identify environmentally-sensitive areas
  - c. Identify poles that are excessively sweating preservative solution
  - d. Ensure familiarity with proper handling and safety precautions
  - e. Identify and report potential contaminant releases from utility poles

# VELCO ENVIRONMENTAL GUIDANCE MANUAL

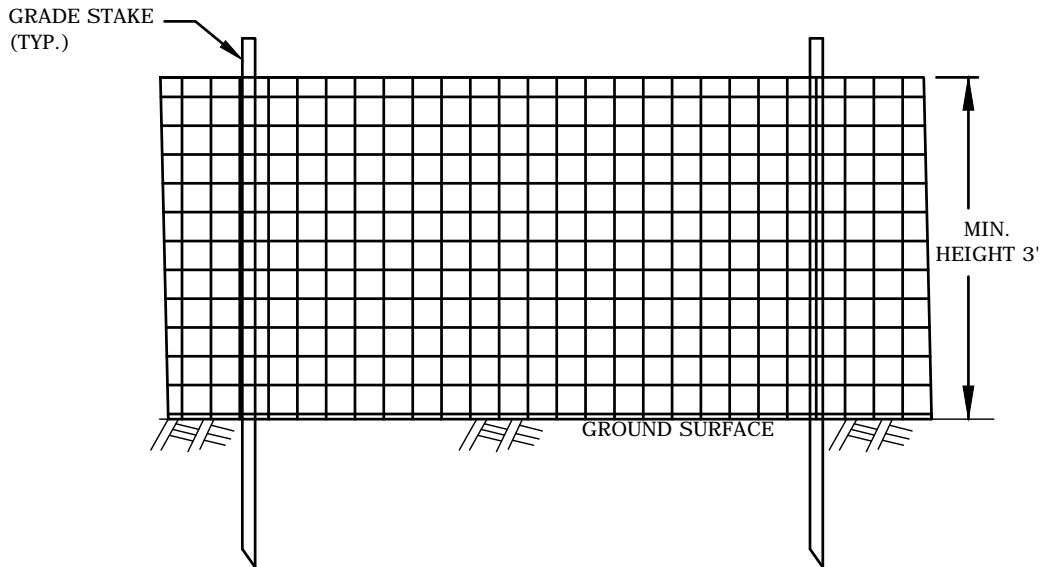
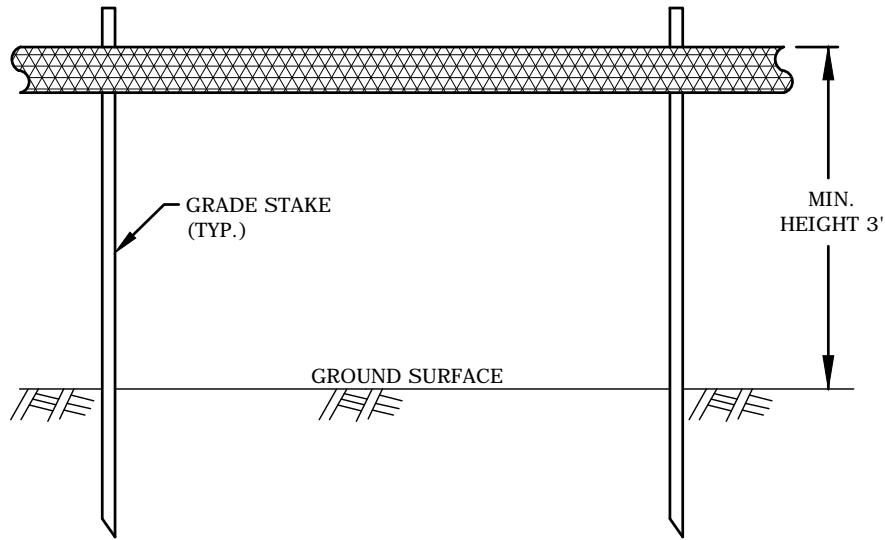

NOTES:

- CONSTRUCTION FENCE OR SAFETY FENCE SHALL BE INSTALLED AROUND THE PERIMETER OF THE PROJECT TO DENOTE THE LIMIT OF DISTURBANCE.
- NO EARTHWORK OR STORAGE OF MATERIALS SHALL BE DONE OUTSIDE OF THIS LIMIT LINE.
- FENCE MAY BE 4" ORANGE BARRIER TAPE OR 1/2" YELLOW POLYPROPYLENE ROPE.
- IN AREAS THAT REQUIRE SPECIAL PROTECTION, ORANGE SNOW FENCE MAY BE USED IN CONJUNCTION WITH OR INSTEAD OF THE 4" BARRIER TAPE .



VERMONT ELECTRIC POWER COMPANY, INC.  
366 PINNACLE RIDGE ROAD  
RUTLAND, VERMONT 05701

## BARRIER FENCE DETAIL

DATE: 08/2023

REV:

REF:

EPSC-1

# VELCO ENVIRONMENTAL GUIDANCE MANUAL

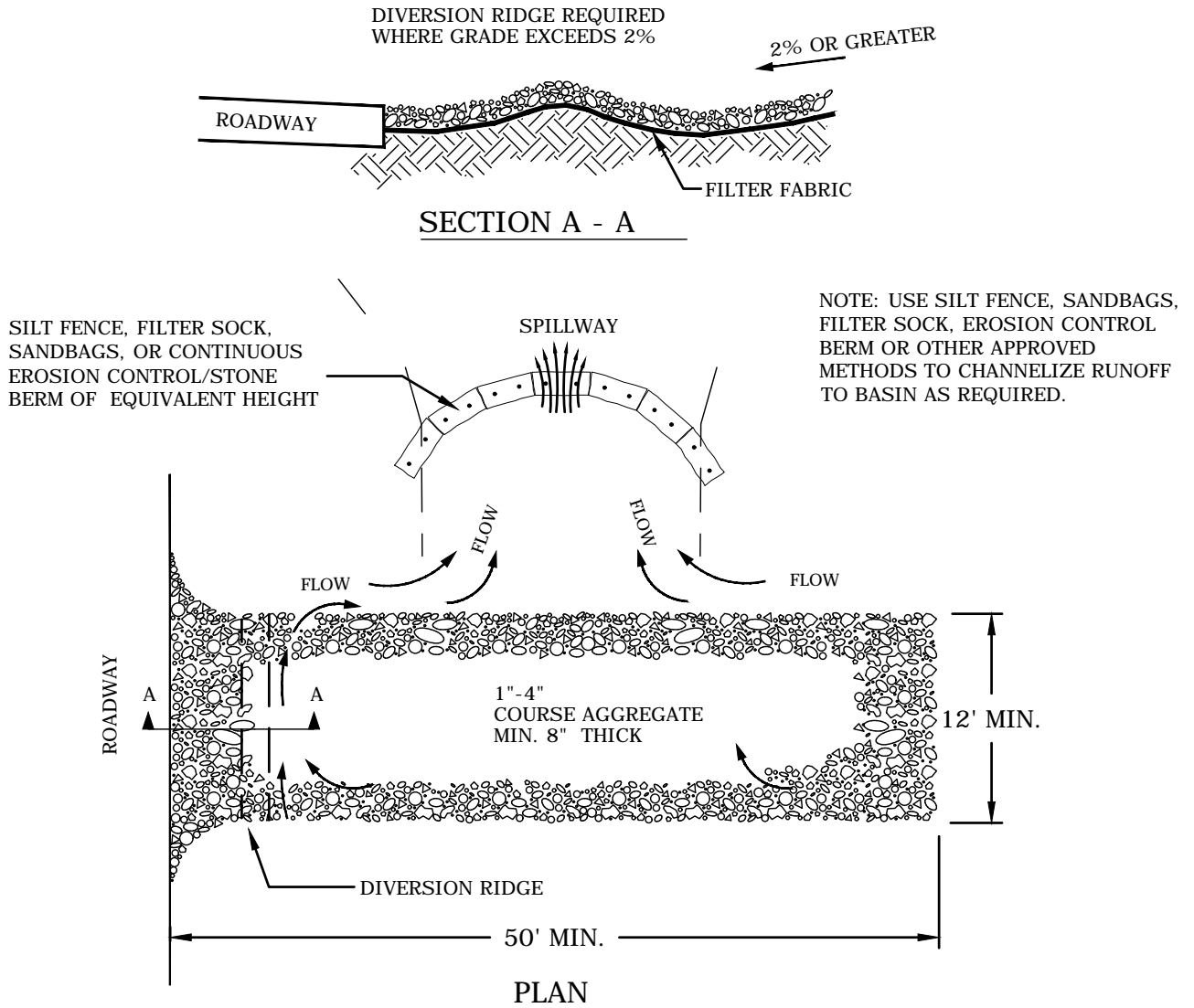

**NOTES:**

1. USE 1" - 4" STONE AT 8" DEPTH, MINIMUM.
2. THE ENTRANCE SHALL BE MAINTAINED IN A CONDITION THAT WILL PREVENT TRACKING OR FLOWING OF SEDIMENT ONTO ROADWAY. THIS MAY REQUIRE TOP DRESSING AND REPAIR, AND/OR CLEAN OUT OF ANY MEASURES USED TO TRAP SEDIMENT.
3. PERFORM ROUTINE INSPECTIONS AND MAINTENANCE, AS NEEDED.
4. WHEN NECESSARY, WHEELS SHALL BE CLEANED PRIOR TO ENTRANCE ONTO PUBLIC RIGHT-OF-WAY.
5. WHEN WASHING IS REQUIRED, IT SHALL BE DONE ON AN AREA STABILIZED WITH CRUSHED STONE THAT DRAINS INTO AN APPROVED SEDIMENT TRAP OR SEDIMENT BASIN.
6. ALL CHANNELIZED WATER FLOWING TOWARD THE CONSTRUCTION ENTRANCE SHALL BE PIPED BENEATH THE ENTRANCE.



VERMONT ELECTRIC POWER COMPANY, INC.  
366 PINNACLE RIDGE ROAD  
RUTLAND, VERMONT 05701

## STABILIZED CONSTRUCTION ENTRANCE DETAIL

DATE: 08/2023

REV:

REF:

EPSC-2

# VELCO ENVIRONMENTAL GUIDANCE MANUAL

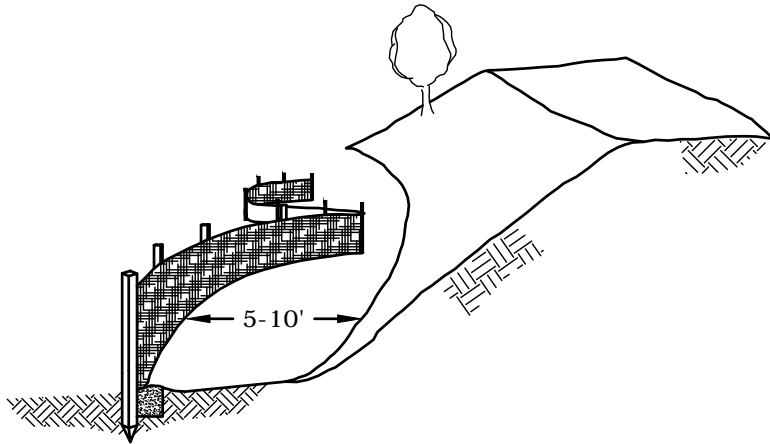

**NOTES:**

1. SILT FENCE SHALL BE PLACED PARALLEL TO THE CONTOURS AND AS CLOSE TO THE LIMITS OF DISTURBANCE AS POSSIBLE WHILE ALLOWING SUFFICIENT ROOM FOR MAINTENANCE ACTIVITIES.
2. PREFABRICATED UNITS SHALL BE MIRAFI® , OR APPROVED EQUIVALENT. MAINTENANCE SHALL BE PERFORMED AS NEEDED TO ENSURE PROPER FUNCTION.
3. SEDIMENT SHALL BE REMOVED WHEN ACCUMULATED TO 1/2 THE FENCE HEIGHT. REMOVED MATERIAL SHALL BE TRANSPORTED TO AN UPLAND LOCATION AND STABILIZED.
4. WHEN TWO SECTIONS OF SILT FENCE ADJOIN EACH OTHER, THEY SHALL BE OVERLAPPED BY 6" AND FOLDED.
5. J-HOOKS OR 'SMILES' ARE PREFERABLE TO LINEAR INSTALLATION.
6. POSTS SHOULD BE NO MORE THAN 6' OFF CENTER (O.C.)

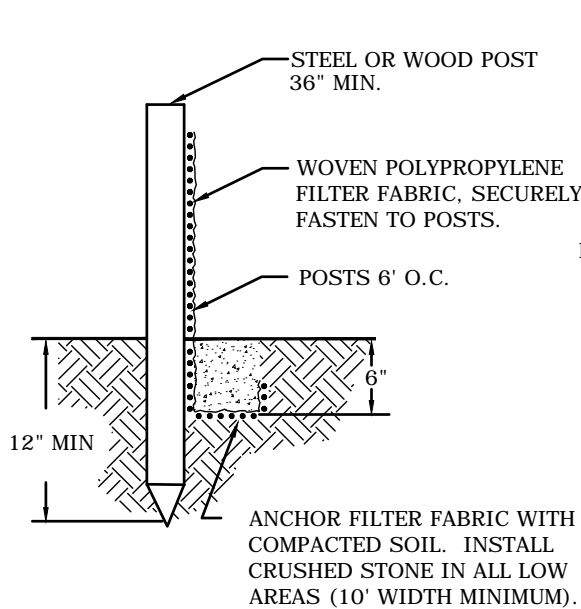

TRENCHED INSTALLATION

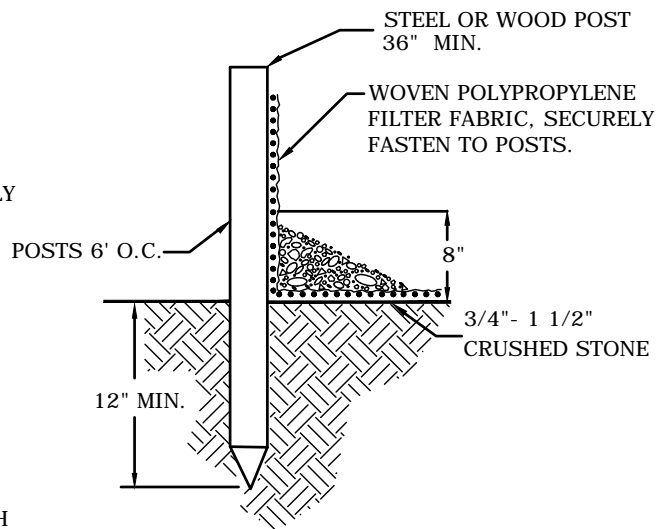

ALTERNATE INSTALLATION

**NOTES:**

1. THIS INSTALLATION INTENDED FOR LOCATIONS WHERE DIGGING CONTINUOUS FLAP IN 6" DEEP IS NOT POSSIBLE OR DESIRABLE.
2. PROVIDE A WATERTIGHT SEAL BETWEEN EXISTING GRADE AND BASE OF FABRIC.
3. PROVIDE CLEAN WASHED STONE 3/4 - 1 1/2" DIA. TO SECURE SEAL.



VERMONT ELECTRIC POWER COMPANY, INC.  
366 PINNACLE RIDGE ROAD  
RUTLAND, VERMONT 05701

SILT FENCE  
DETAIL

DATE: 08/2023

REV:

REF:

EPSC-3

# VELCO ENVIRONMENTAL GUIDANCE MANUAL

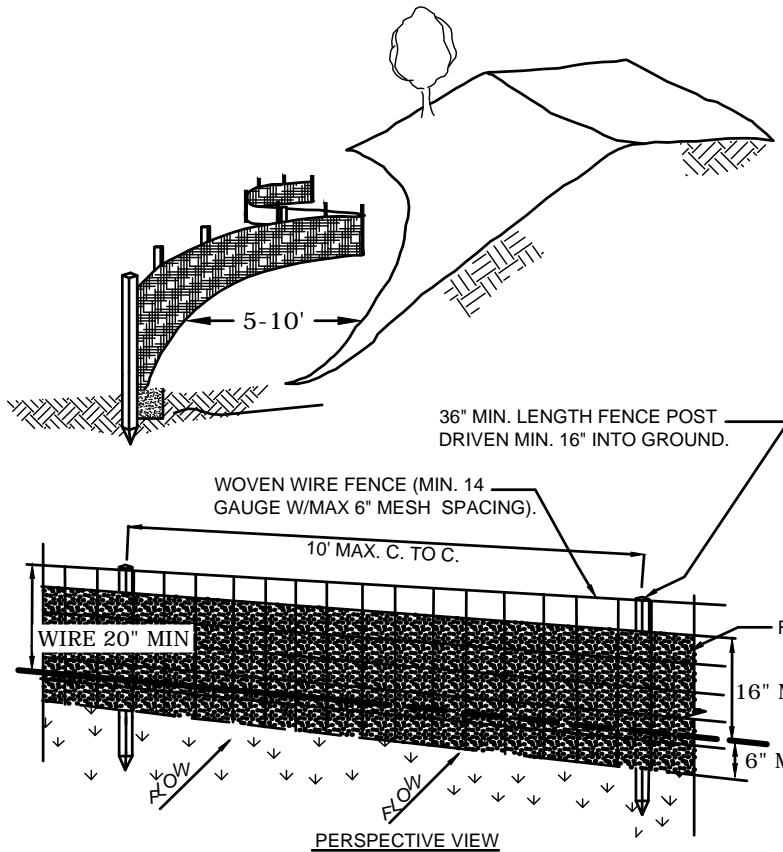

**NOTES:**

1. WOVEN WIRE FENCE TO BE FASTENED SECURELY TO FENCE POSTS WITH WIRE TIES. WIRE FENCE REINFORCEMENT REQUIRED WITHIN 50 FT UPSLOPE OF PROTECTED RESOURCES.
2. FILTER CLOTH TO BE FASTENED SECURELY TO WOVEN WIRE FENCE WITH TIES SPACED EVERY 24" AT TOP AND MID SECTION. FENCE SHALL BE WOVEN WIRE 6" MAXIMUM MESH OPENING.
3. WHEN TWO SECTIONS OF FILTER CLOTH ADJOIN EACH OTHER THEY SHALL BE OVERLAPPED BY SIX INCHES AND FOLDED. FILTER CLOTH SHALL BE EITHER FILTER X, MIRAFI 100X, STABILINKA T140N, OR APPROVED EQUIVALENT.
4. PREFABRICATED UNITS SHALL BE GEOFAB, ENVIFENCE, OR APPROVED EQUIVALENT.
5. MAINTENANCE SHALL BE PERFORMED AS NEEDED AND MATERIAL REMOVED WHEN SEDIMENTS REACH 1/2 OF FABRIC HEIGHT.

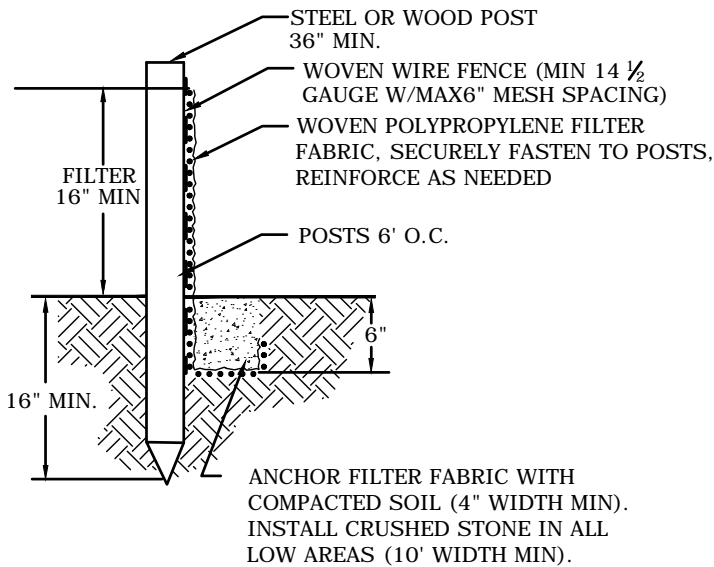

**TRENCHED INSTALLATION**

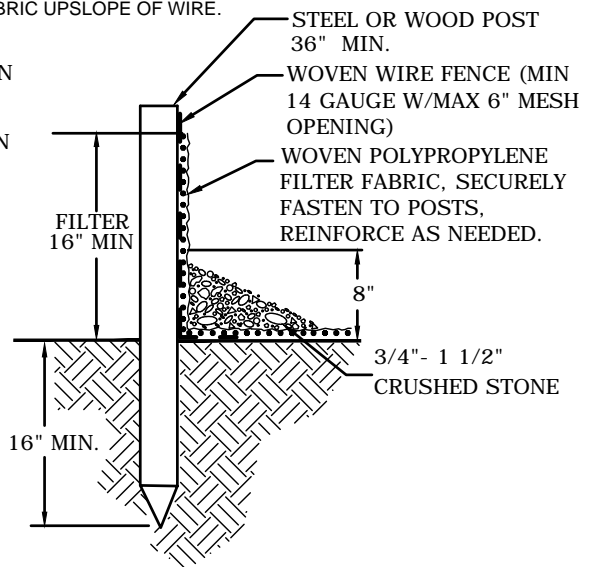

**ALTERNATE INSTALLATION**

**NOTES:**

1. THIS INSTALLATION INTENDED FOR LOCATIONS WHERE DIGGING CONTINUOUS FLAP IN 6" NOT POSSIBLE OR DESIRABLE.
2. PROVIDE A WATERTIGHT SEAL BETWEEN EXISTING GRADE AND BASE OF FABRIC.
3. PROVIDE CLEAN WASHED STONE 3/4 - 1 1/2" DIA. TO SECURE SEAL.



VERMONT ELECTRIC POWER COMPANY, INC.  
366 PINNACLE RIDGE ROAD  
RUTLAND, VERMONT 05701

## REINFORCED SILT FENCE

### DETAIL

DATE: 08/2023

REV:

REF:

EPSC-4

# VELCO ENVIRONMENTAL GUIDANCE MANUAL

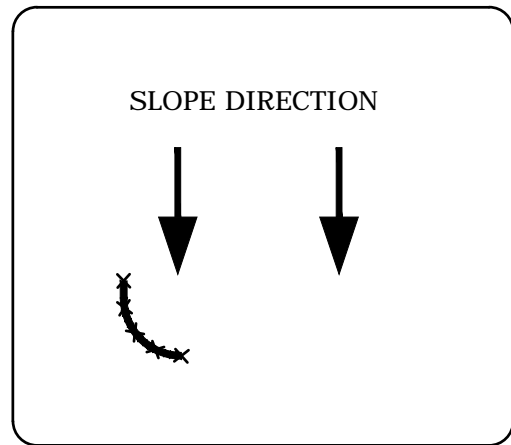
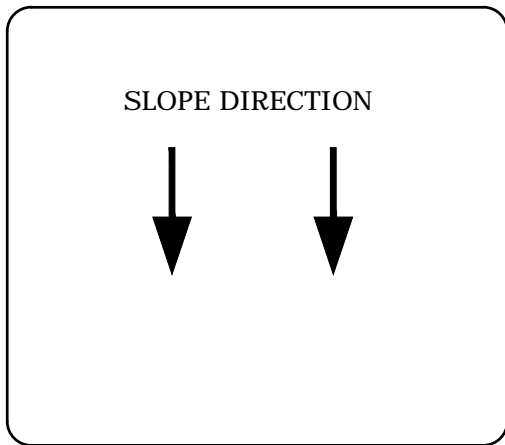

STEP 1 - CONSTRUCT "LEG"

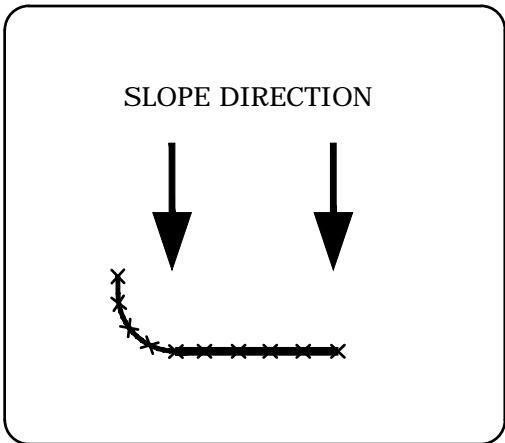

STEP 2 - CONSTRUCT "DAM"

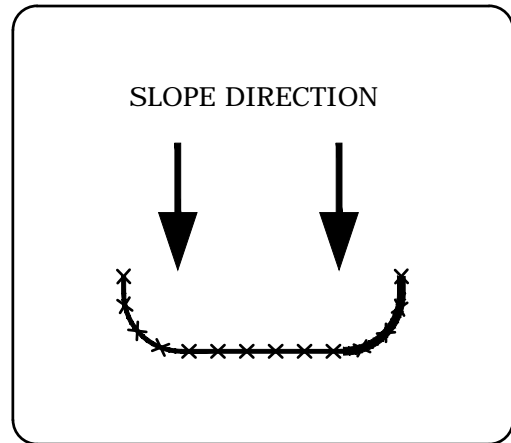

STEP 3 - CONSTRUCT "LEG 2"

INSTALLATION WITH J-HOOKS OR 'SMILES' INCREASE SILT FENCE EFFICIENCY.



VERMONT ELECTRIC POWER COMPANY, INC.  
366 PINNACLE RIDGE ROAD  
RUTLAND, VERMONT 05701

## SILT FENCE- ONE SLOPE DETAIL

DATE: 08/2023

REV:

REF:

EPSC-5



# VELCO ENVIRONMENTAL GUIDANCE MANUAL

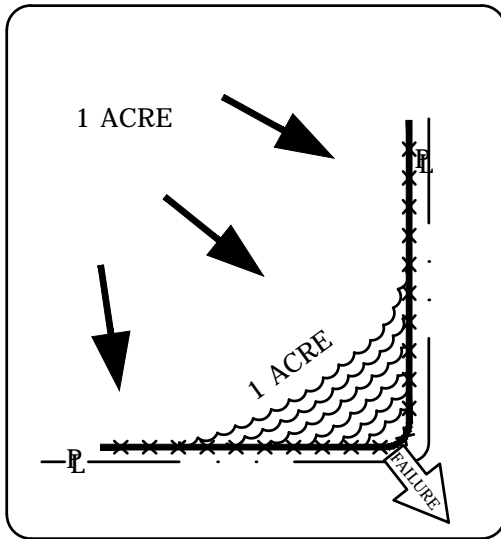

INCORRECT - DO NOT LAYOUT "PERIMETER CONTROL" SILT FENCES ALONG PROPERTY LINES. ALL SEDIMENT LADEN RUNOFF WILL CONCENTRATE AND OVERWHELM THE SYSTEM.

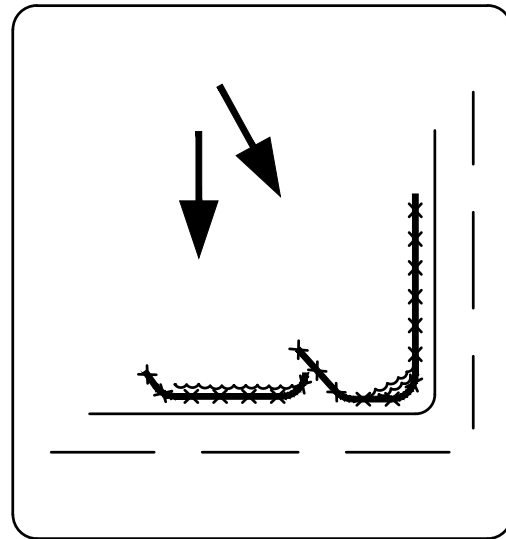

CORRECT - INSTALL J-HOOKS

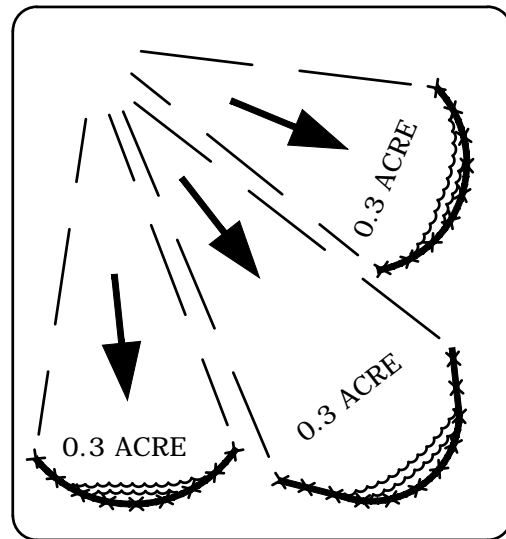
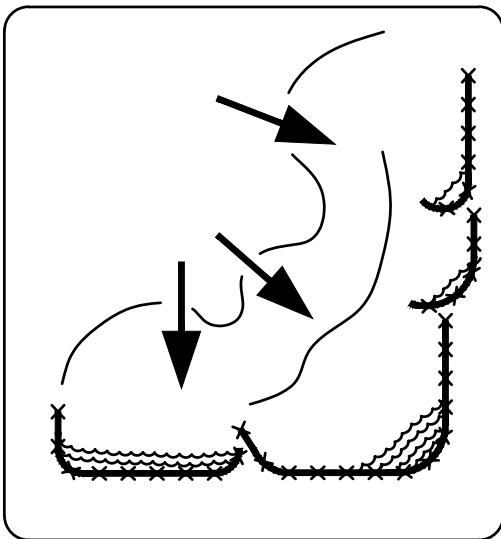

DISCREET SEGMENTS OF SILT FENCE, INSTALLED WITH J-HOOKS OR 'SMILES' WILL BE MORE EFFECTIVE.



VERMONT ELECTRIC POWER COMPANY, INC.  
366 PINNACLE RIDGE ROAD  
RUTLAND, VERMONT 05701

## SILT FENCE-PERIMETER DETAIL

DATE: 08/2023

REV:

REF:

EPSC-6

# VELCO ENVIRONMENTAL GUIDANCE MANUAL

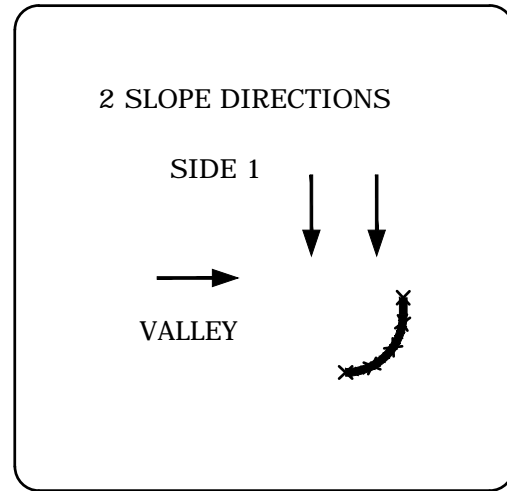
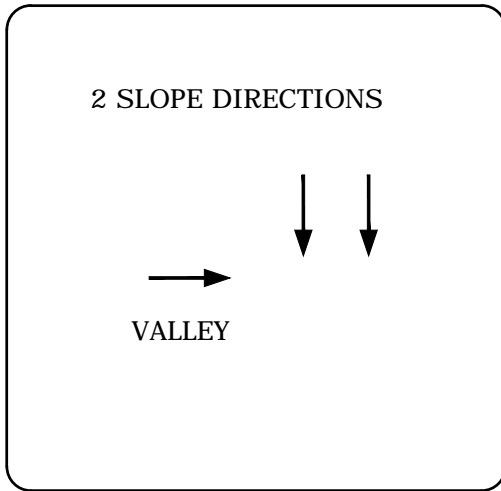

STEP 1 - CONSTRUCT A "DAM"

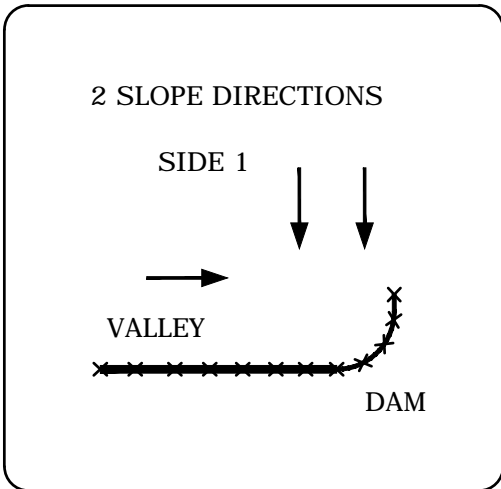

STEP 2 - CONSTRUCT SIDE 2

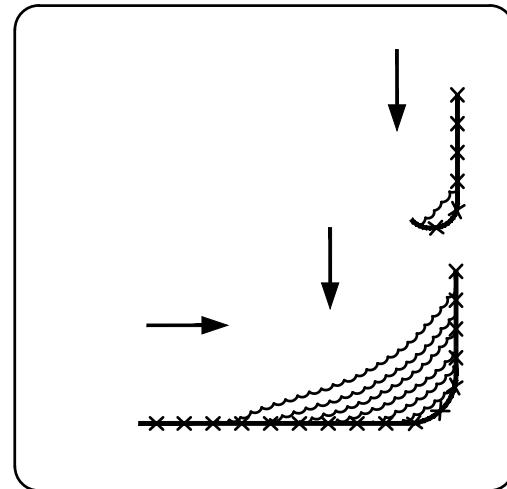

STEP 3 - CONSTRUCT "J-HOOKS"  
AS NEEDED

INSTALLATION WITH J-HOOKS WILL INCREASE SILT FENCE EFFICIENCY AND  
REDUCE EROSION-CAUSING FAILURES.



VERMONT ELECTRIC POWER COMPANY, INC.  
366 PINNACLE RIDGE ROAD  
RUTLAND, VERMONT 05701

SILT FENCE-TWO SLOPES

DETAIL

DATE: 08/2023

REV:

REF:

EPSC-7

# VELCO ENVIRONMENTAL GUIDANCE MANUAL

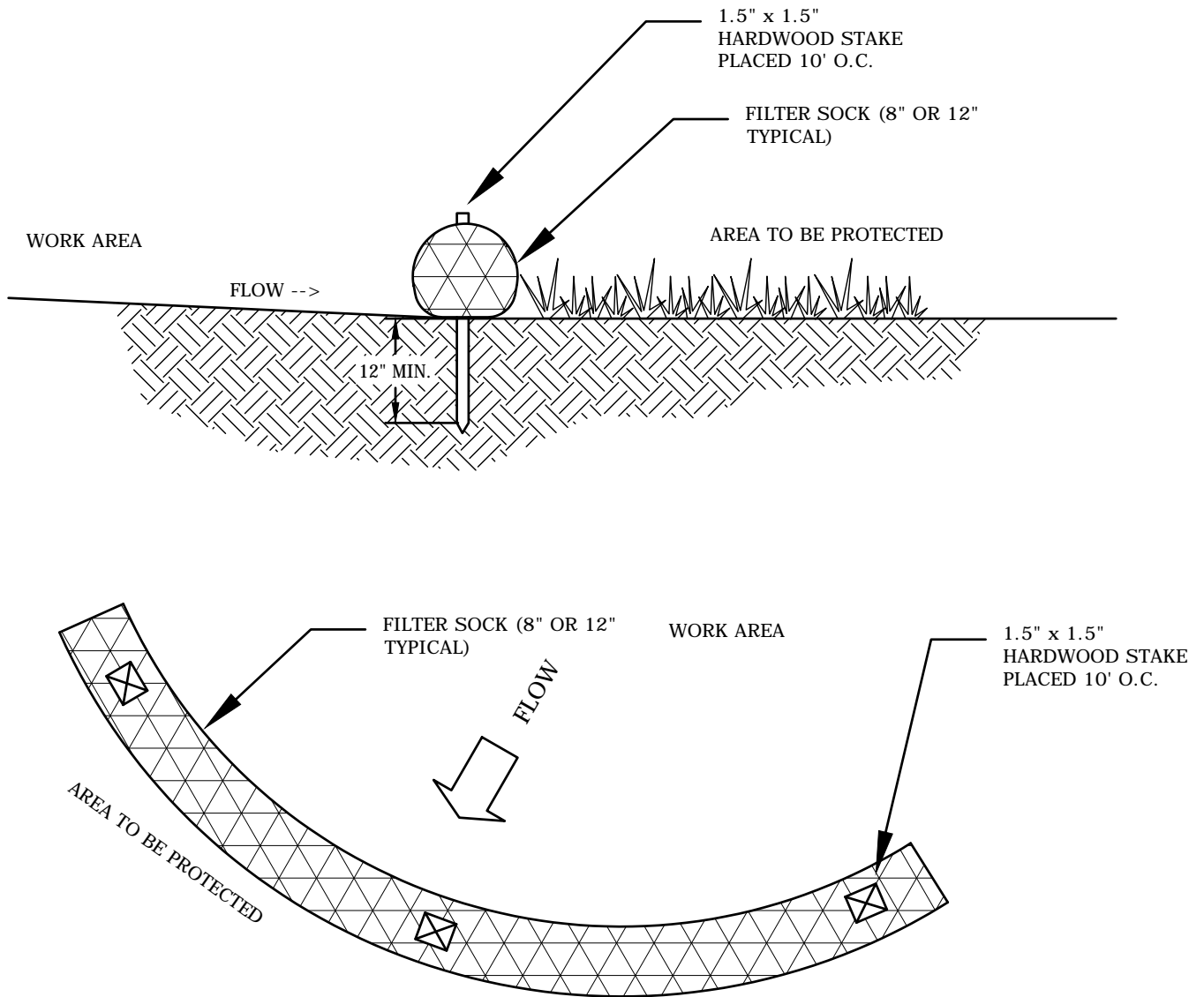

**NOTES:**

1. FILTER SOCK SHALL CONSIST OF ORGANIC MATERIALS (FILTREXX OR SIMILAR)
2. PERIMETER CONTROL SHOULD BE INSTALLED PARALLEL TO THE BASE OF THE SLOPE OR OTHER DISTURBED AREA. IN CHALLENGING CONDITIONS (I.E., 2:1 SLOPES), A SECOND PERIMETER CONTROL SHALL BE CONSTRUCTED AT THE TOP OF THE SLOPE, OR STAKING MAY BE INCREASED.
3. STAKES SHOULD BE INSTALLED THROUGH THE MIDDLE OF THE PERIMETER CONTROL ON 10 FT CENTERS, USING NOMINAL 2 IN BY 2 IN BY 3 FT WOODEN STAKES. 5" DIAMETER SOCK MAY USE 1" X 1" X 18" WOODEN STAKES. IN THE EVENT STAKING IS NOT POSSIBLE, SAND BAGS (OR EQUIVALENT) MAY BE USED TO STABILIZE SOCK.
4. ALTERNATIVELY, STAKES MAY BE INSTALLED DIRECTLY BEHIND THE SOCK AT A 90-DEGREE ANGLE TO LEVEL GROUND (REGARDLESS OF SLOPE ANGLE), WHERE STAKES ARE IN DIRECT CONTACT WITH THE DOWNSLOPE SIDE OF SOCK.
5. STRAIGHTEN OR POSITION THE SOCK AS NEEDED ON THE GROUND, ENSURING THERE IS ADEQUATE GROUND CONTACT AND NO VOIDS BENEATH THE SOCK.
6. THE FILTER MEDIA WILL BE DISPERSED ON SITE ONCE DISTURBED AREA HAS BEEN PERMANENTLY STABILIZED, CONSTRUCTION ACTIVITY HAS CEASED, OR AS DIRECTED BY THE ENVIRONMENTAL INSPECTOR.



VERMONT ELECTRIC POWER COMPANY, INC.  
366 PINNACLE RIDGE ROAD  
RUTLAND, VERMONT 05701

## FILTER SOCK DETAIL

DATE: 08/2023

REV:

REF:

EPSC-8

# VELCO ENVIRONMENTAL GUIDANCE MANUAL

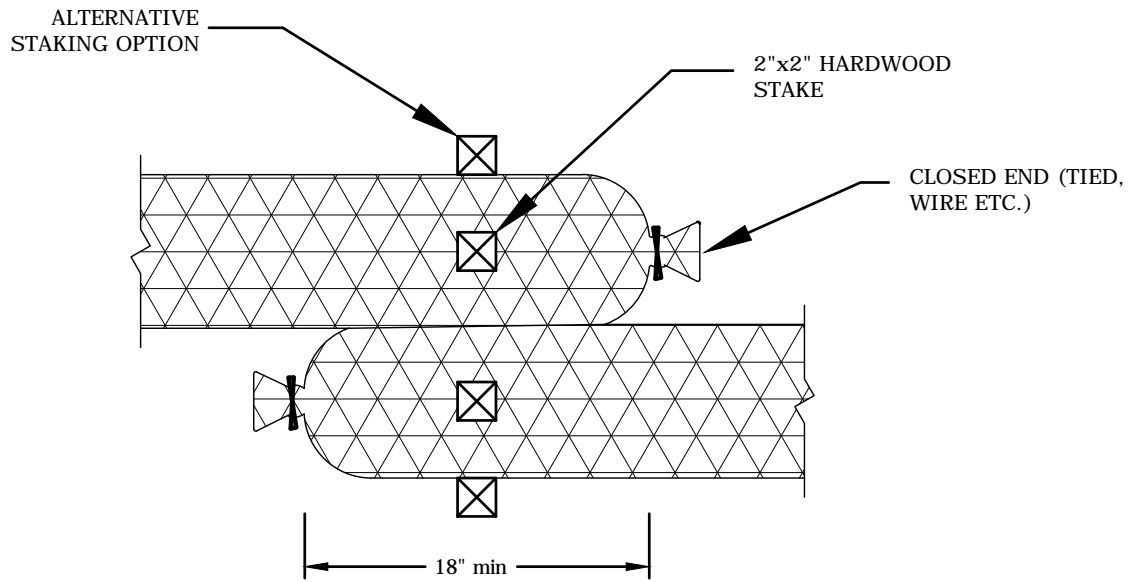

CONNECTION DETAIL

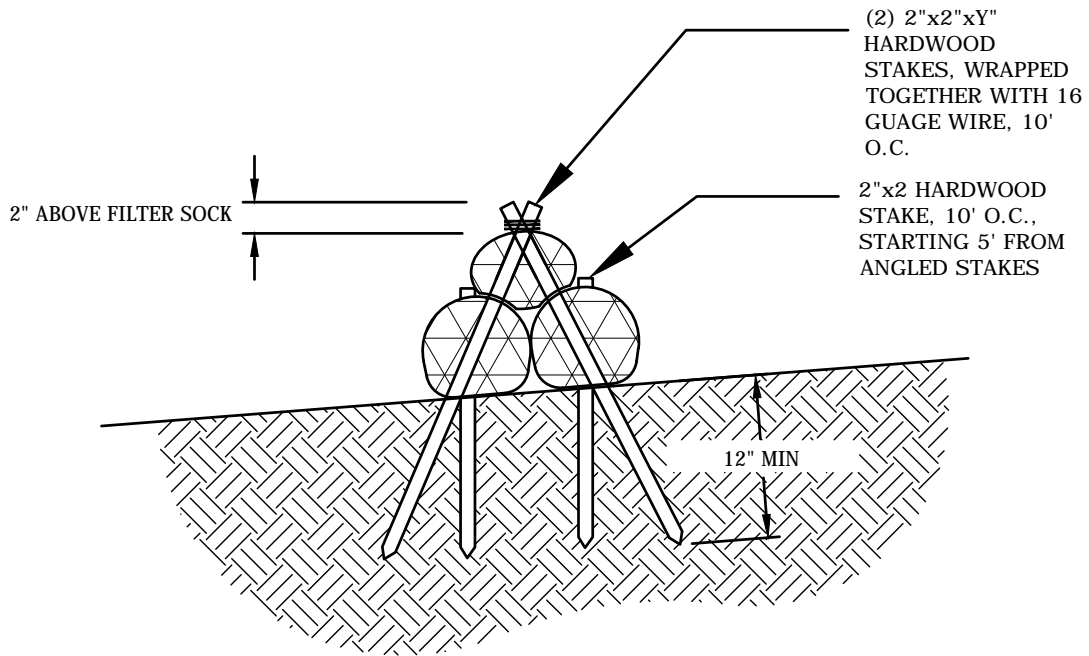

PYRAMID STACK DETAIL



VERMONT ELECTRIC POWER COMPANY, INC.  
 366 PINNACLE RIDGE ROAD  
 RUTLAND, VERMONT 05701

## FILTER SOCK CONNECTION & STACK DETAILS

DATE: 08/2023

REV:

REF:

EPSC-9

# VELCO ENVIRONMENTAL GUIDANCE MANUAL

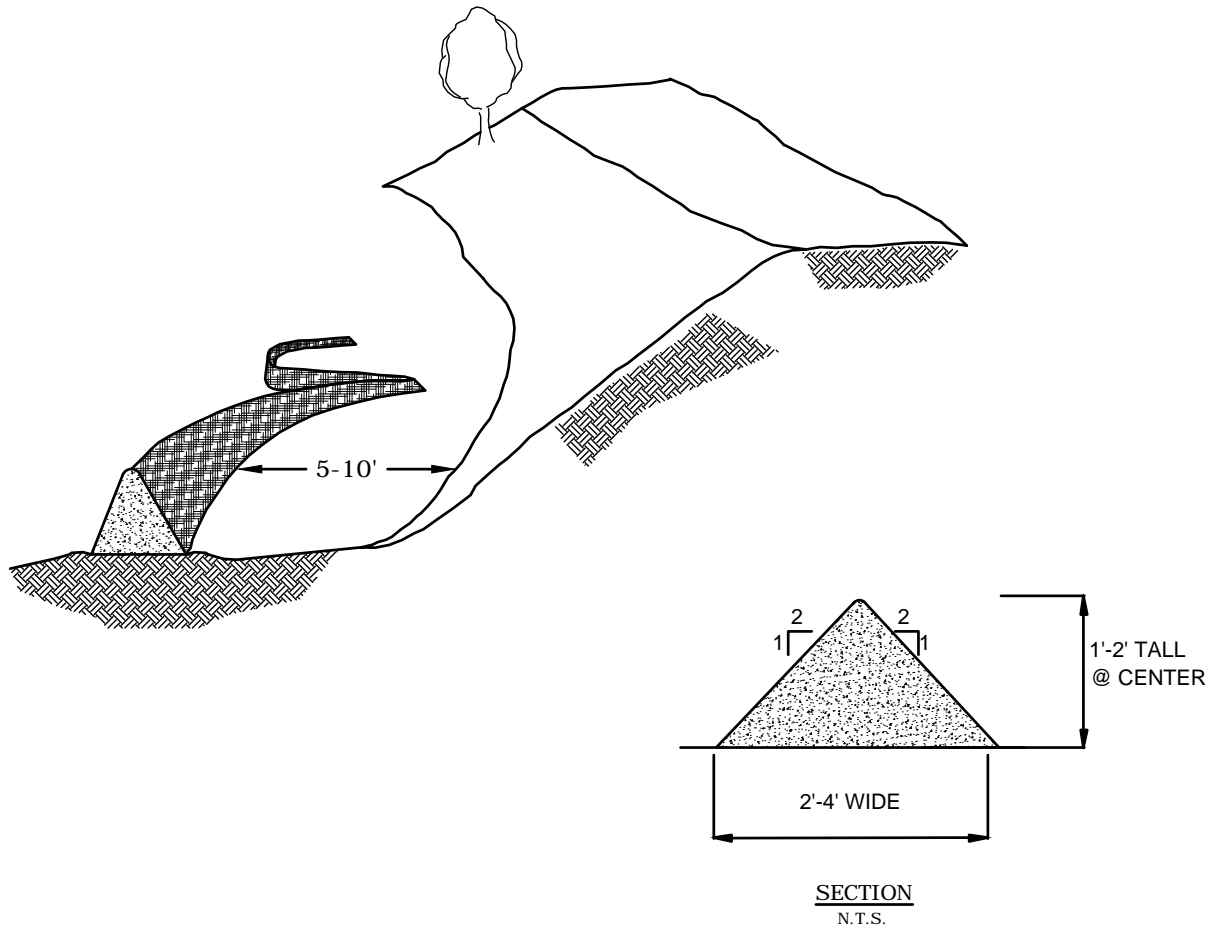

## NOTES

1. EROSION CONTROL BERM MAY BE USED IN PLACE OF SILT FENCE, WHEN "KEYING-IN" IS NOT FEASIBLE.
2. BERM SHOULD BE COMPRISED OF A DENSE, PROCESSED MIXTURE OF INTERTWINING WOOD FRAGMENTS AND GRIT. COMMON SOURCES INCLUDE STUMP GRINDINGS AND AGED WOOD WASTE AND MAY ALSO CONTAIN SHREDDED BARK AS PART OF THE MIX.
3. WELL-GRADED AND WASHED (FREE OF FINES) STONE, MAY BE USED AS A SUBSTITUTE IF SUITABLE ORGANIC MATERIAL IS NOT AVAILABLE. STONE SHOULD BE SIZED BASED ON THE CONDITIONS (SLOPE, ANTICIPATED FLOW, ETC.) GENERALLY 2"-9" IN SIZE.
4. EROSION CONTROL BERM SHOULD BE BETWEEN 1'- 2' TALL AND BETWEEN 2'-4' WIDE.
5. CONSTRUCT BERM PARALLEL TO CONTOURS WITH ENDS TURNED UPSLOPE TO PREVENT BYPASS.
6. THE BERM SHOULD NOT BE PLACED IN AREAS OF CONCENTRATED FLOW.



VERMONT ELECTRIC POWER COMPANY, INC.  
366 PINNACLE RIDGE ROAD  
RUTLAND, VERMONT 05701

EROSION CONTROL BERM

DETAIL

DATE: 08/2023

REV:

REF:

EPSC-10

# VELCO ENVIRONMENTAL GUIDANCE MANUAL

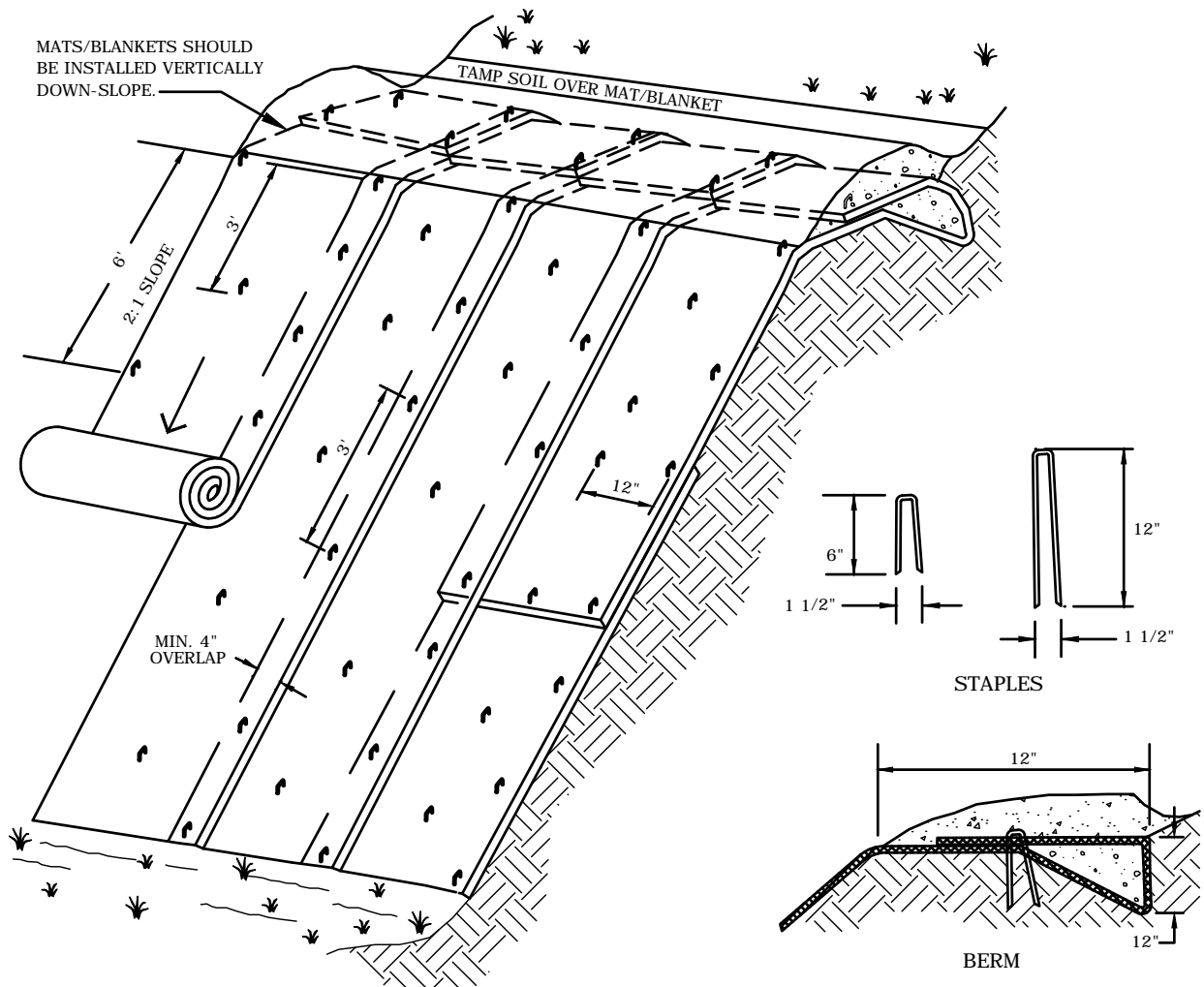

**NOTES:**

1. ROLLED EROSION CONTROL PRODUCT (RECP) MUST BE LOOSE WEAVE, NATURAL FIBER, WITH NON-BONDED JOINTS, SUCH AS NORTH AMERICAN GREEN S75BN, S150BN, SC150BN OR APPROVED EQUIVALENT, DEPENDING ON SLOPE AND APPLICATION.
2. PLASTIC MESH (WHETHER BIODEGRADABLE OR NOT) CAN ENSNARE ANIMALS SUCH AS SNAKES AND BIRDS. AS SUCH ONLY NATURAL FIBER WOVEN AND INTERLINKED PRODUCTS ARE APPROVED FOR USE.
3. SLOPE SURFACE SHALL BE FREE OF ROCKS, LARGE CLOUDS AND STUMPS. RECP SHALL HAVE GOOD SOIL CONTACT.
4. APPLY SEED AND ANY NECESSARY SOIL AMENDMENTS BEFORE PLACING RECP.
5. LAY RECP LOOSELY AND STAKE OR STAPLE TO MAINTAIN DIRECT CONTACT WITH THE SOIL. DO NOT STRETCH.
6. CHECK SLOTS TO BE CONSTRUCTED PER MANUFACTURER'S SPECIFICATIONS.
7. STAKING OR STAPLING LAYOUT PER MANUFACTURERS SPECIFICATIONS.



VERMONT ELECTRIC POWER COMPANY, INC.  
366 PINNACLE RIDGE ROAD  
RUTLAND, VERMONT 05701

## ROLLED EROSION CONTROL PRODUCT DETAIL

DATE: 08/2023

REV:

REF:

EPSC-11

# VELCO ENVIRONMENTAL GUIDANCE MANUAL

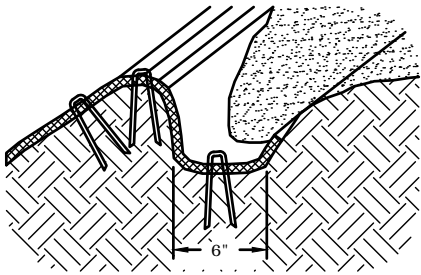

LONGITUDINAL ANCHOR TRENCH

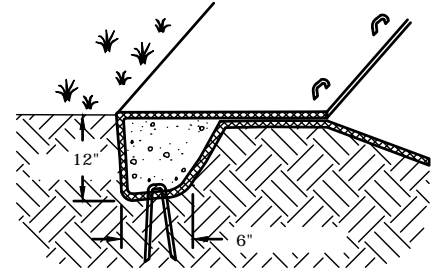

TERMINAL SLOPE AND CHANNEL ANCHOR TRENCH

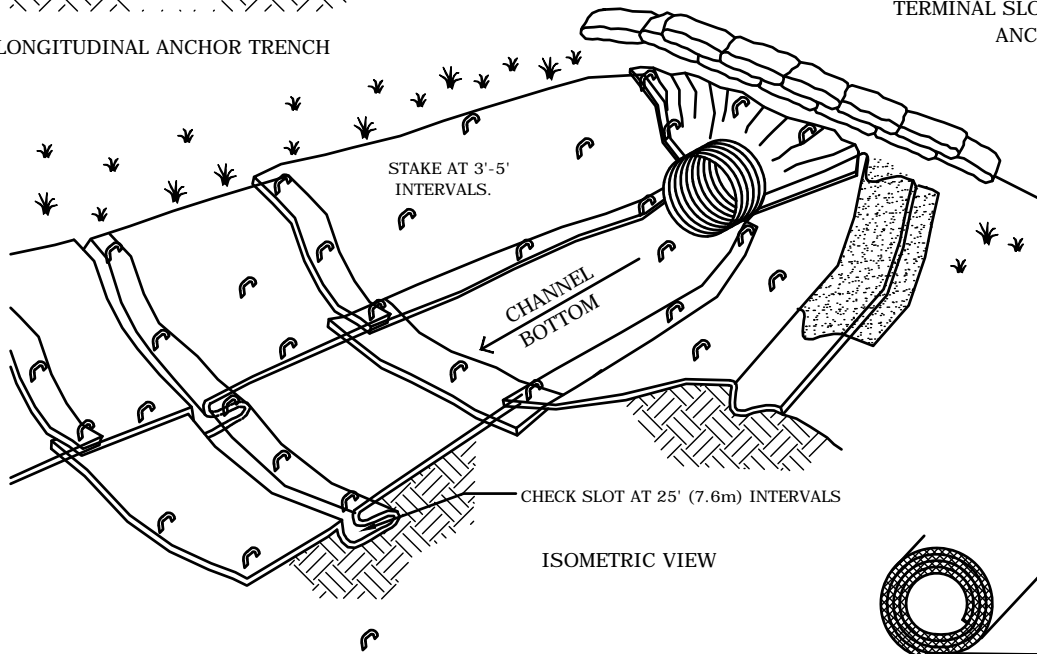

ISOMETRIC VIEW

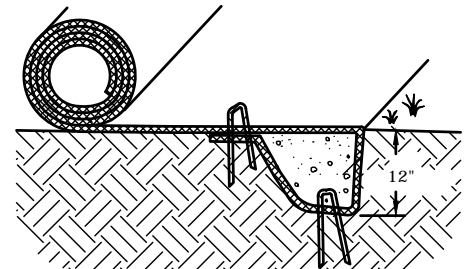

INITIAL CHANNEL ANCHOR TRENCH

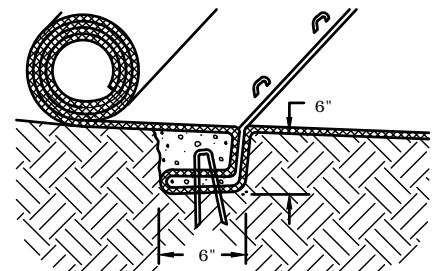

INTERMITTENT CHECK SLOT

NOTES:

1. ROLLED EROSION CONTROL PRODUCT (RECP) MUST BE LOOSE WEAVE, NATURAL FIBER, WITH NON-BONDED JOINTS, SUCH AS NORTH AMERICAN GREEN S75BN, S150BN, SC150BN OR APPROVED EQUIVALENT, DEPENDING ON SLOPE AND APPLICATION.
2. PLASTIC MESH (WHETHER BIODEGRADABLE OR NOT) CAN ENSNARE ANIMALS SUCH AS SNAKES AND BIRDS. AS SUCH ONLY NATURAL FIBER WOVEN AND INTERLINKED PRODUCTS ARE APPROVED FOR USE.
3. SLOPE SURFACE SHALL BE FREE OF ROCKS, LARGE CLODS AND STUMPS. RECP SHALL HAVE GOOD SOIL CONTACT.
4. APPLY SEED AND ANY NECESSARY SOIL AMENDMENTS BEFORE PLACING RECP.
5. LAY RECP LOOSELY AND STAKE OR STAPLE TO MAINTAIN DIRECT CONTACT WITH THE SOIL. DO NOT STRETCH.
6. CHECK SLOTS TO BE CONSTRUCTED PER MANUFACTURER'S SPECIFICATIONS.
7. STAKING OR STAPLING LAYOUT PER MANUFACTURERS SPECIFICATIONS.



VERMONT ELECTRIC POWER COMPANY, INC.  
366 PINNACLE RIDGE ROAD  
RUTLAND, VERMONT 05701

RECP

CHANNEL DETAIL

DATE: 08/2023

REV:

REF:

EPSC-12



# VELCO ENVIRONMENTAL GUIDANCE MANUAL

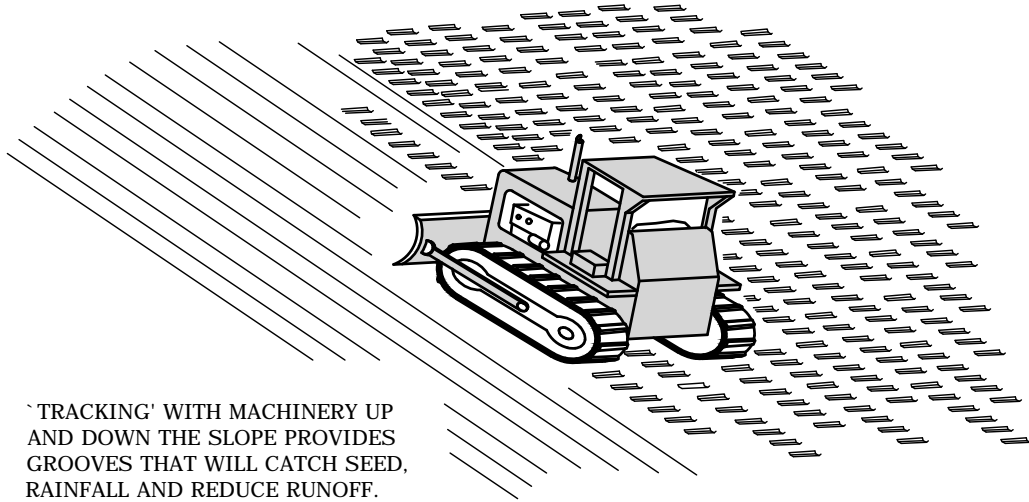

## SEED BED PREPARATION

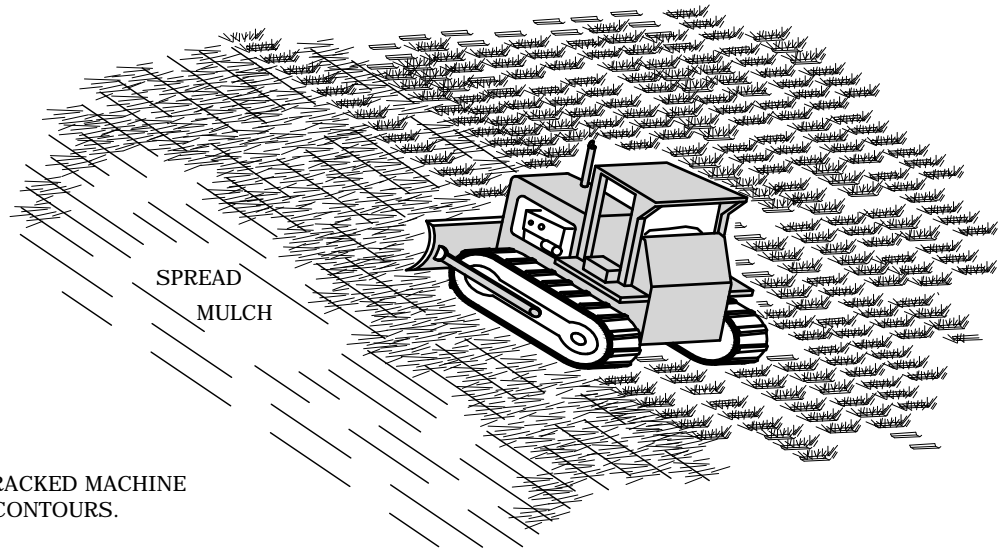

## MULCH ANCHORING

### NOTES:

1. ROUGHEN SLOPE WITH TRACKED MACHINE PERPENDICULAR TO THE CONTOURS.
2. APPLY SEED AND ANY NECESSARY SOIL AMENDMENTS.
3. SPREAD MULCH AT A RATE OF 2 TONS PER ACRE (DOUBLE THIS APPLICATION RATE FOR WINTER CONSTRUCTION).
4. PUNCH MULCH INTO SLOPE BY RUNNING TRACKED MACHINE UP AND DOWN SLOPE PERPENDICULAR TO THE CONTOURS.



VERMONT ELECTRIC POWER COMPANY, INC.  
366 PINNACLE RIDGE ROAD  
RUTLAND, VERMONT 05701

MULCH ANCHORING

DETAIL

DATE: 08/2023

REV:

REF:

EPSC-13

# VELCO ENVIRONMENTAL GUIDANCE MANUAL

## STONE CHECK DAM

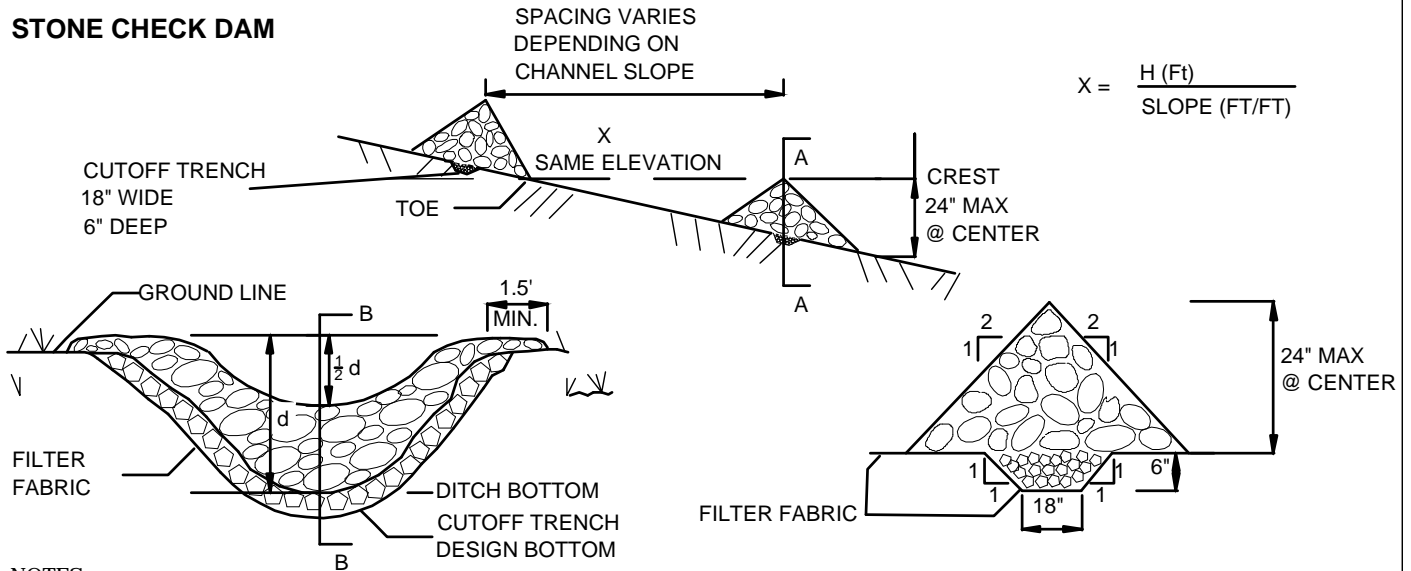

### NOTES:

1. STONE WILL BE PLACED ON A FILTER FABRIC FOUNDATION TO THE LINES, GRADES, AND LOCATIONS SHOWN IN THE PLAN.
2. SET SPACING OF CHECK DAMS TO ASSUME THAT THE ELEVATIONS OF THE CREST OF THE DOWNSTREAM DAM IS AT THE SAME ELEVATION OF THE TOE OF THE UPSTREAM DAM.
3. EXTEND THE STONE A MINIMUM OF 1.5 FEET BEYOND THE DITCH BANKS TO PREVENT CUTTING AROUND THE DAM.
4. PROTECT THE CHANNEL DOWNSTREAM OF THE LOWEST CHECK DAM FROM SCOUR AND EROSION WITH STONE OR LINER AS NEEDED.
5. USE WELL GRADED STONE 2" - 9" IN SIZE.
6. SEDIMENT SHOULD BE REMOVED FROM BEHIND THE CHECK DAM ONCE THE ACCUMULATED HEIGHT HAS REACHED ONE-HALF THE HEIGHT OF THE CHECK DAM. STABILIZE AS SOON AS POSSIBLE.

## Alt. FIBER CHECK DAM

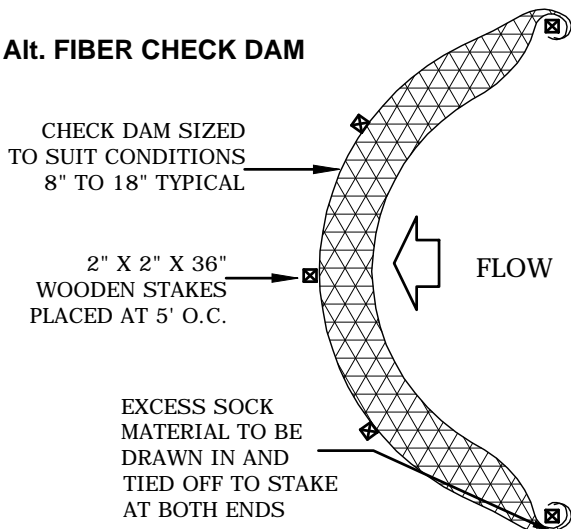

### NOTES:

1. ALL MATERIAL TO MEET FILTREXX® (OR EQUIVALENT MANUFACTURER) SPECIFICATIONS.
2. CHECK DAM SHOULD BE USED IN AREAS THAT DRAIN 10 ACRES OR LESS.
3. SEDIMENT SHOULD BE REMOVED FROM BEHIND THE CHECK DAM ONCE THE ACCUMULATED HEIGHT HAS REACHED ONE-HALF THE HEIGHT OF THE CHECK DAM, STABILIZE AS SOON AS POSSIBLE.
4. CHECK DAM CAN BE DIRECT SEEDING AT THE TIME OF INSTALLATION.



VERMONT ELECTRIC POWER COMPANY, INC.  
366 PINNACLE RIDGE ROAD  
RUTLAND, VERMONT 05701

## CHECK DAM DETAIL

DATE: 08/2023

REV:

REF:

EPSC-14

# VELCO ENVIRONMENTAL GUIDANCE MANUAL

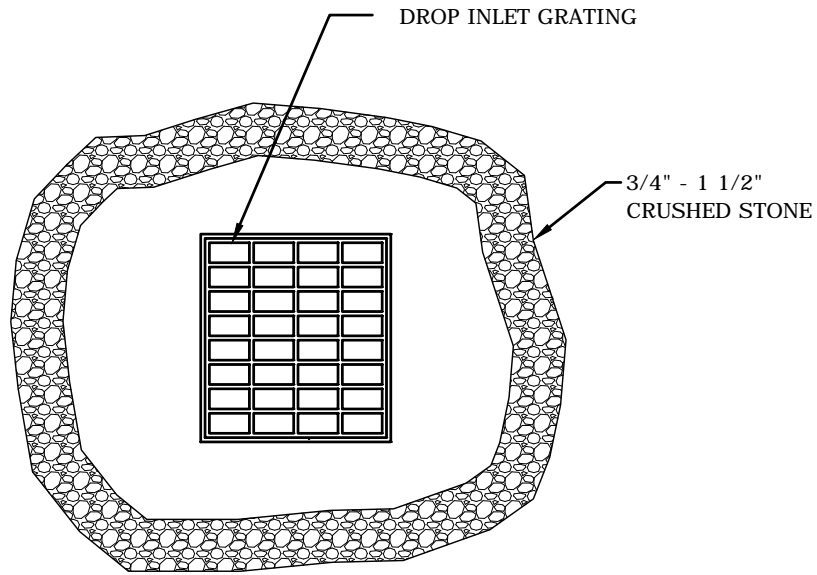

PLAN VIEW

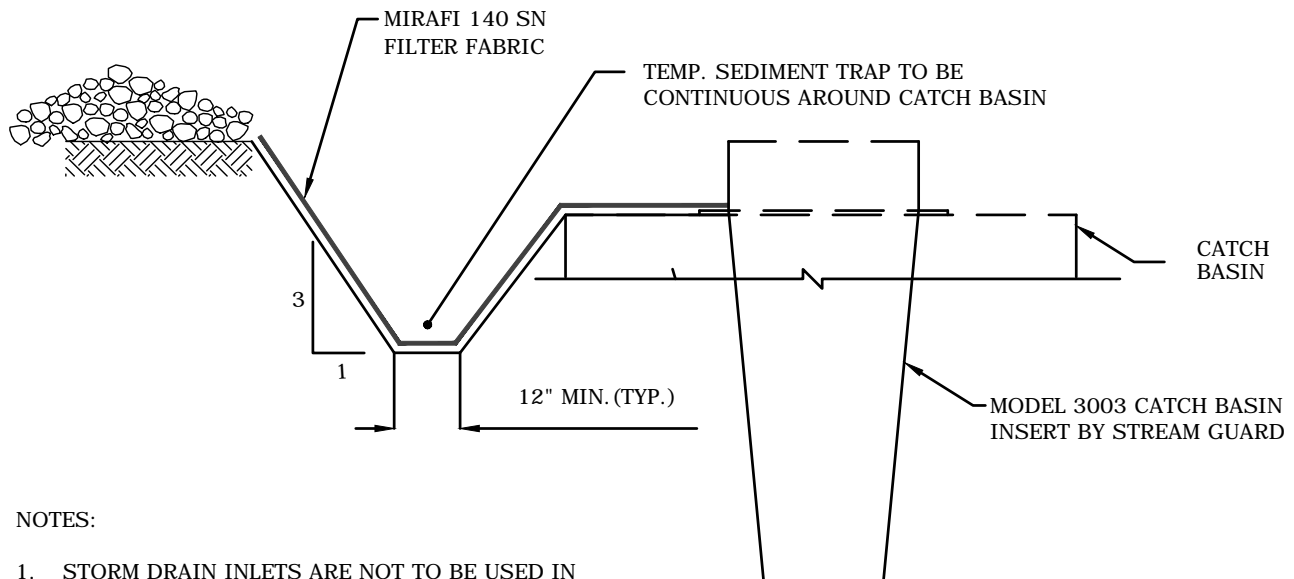

NOTES:

1. STORM DRAIN INLETS ARE NOT TO BE USED IN PLACE OF SEDIMENT TRAPPING DEVICES. THEY SHOULD BE USED IN CONJUNCTION WITH STORM DRAIN DIVERSION TO HELP PREVENT SILTATION OF PIPES INSTALLED WITH LOW SLOPE ANGLES.
2. DRAINAGE AREA SHALL NOT EXCEED ONE ACRE.



VERMONT ELECTRIC POWER COMPANY, INC.  
366 PINNACLE RIDGE ROAD  
RUTLAND, VERMONT 05701

## STONE INLET PROTECTION DETAIL

DATE: 08/2023

REV:

REF:

EPSC-15

# VELCO ENVIRONMENTAL GUIDANCE MANUAL

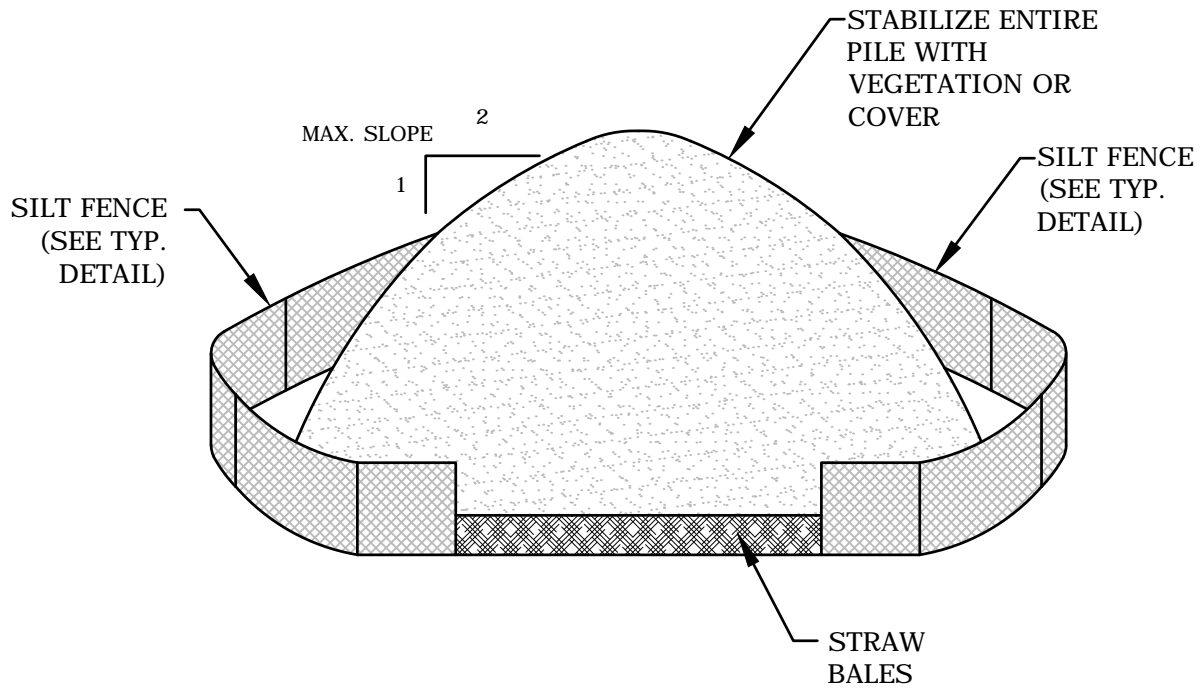

**NOTES:**

1. AREA CHOSEN FOR STOCKPILING OPERATIONS SHALL BE DRY AND STABLE.
2. MAXIMUM SLOPE OF STOCKPILE SHALL BE 2H:1V.
3. UPON COMPLETION OF SOIL STOCKPILING, EACH PILE SHALL BE SURROUNDED WITH EITHER SILT FENCING OR STRAW BALES, THEN STABILIZED WITH VEGETATION OR COVERED. (MULCH, WOOD CHIPS, ROLLED EROSION CONTROL PRODUCT, OR POLY SHEETING)



VERMONT ELECTRIC POWER COMPANY, INC.  
 366 PINNACLE RIDGE ROAD  
 RUTLAND, VERMONT 05701

## SOIL STOCKPILE DETAIL

DATE: 08/2023

REV:

REF:

EPSC-16

# VELCO ENVIRONMENTAL GUIDANCE MANUAL

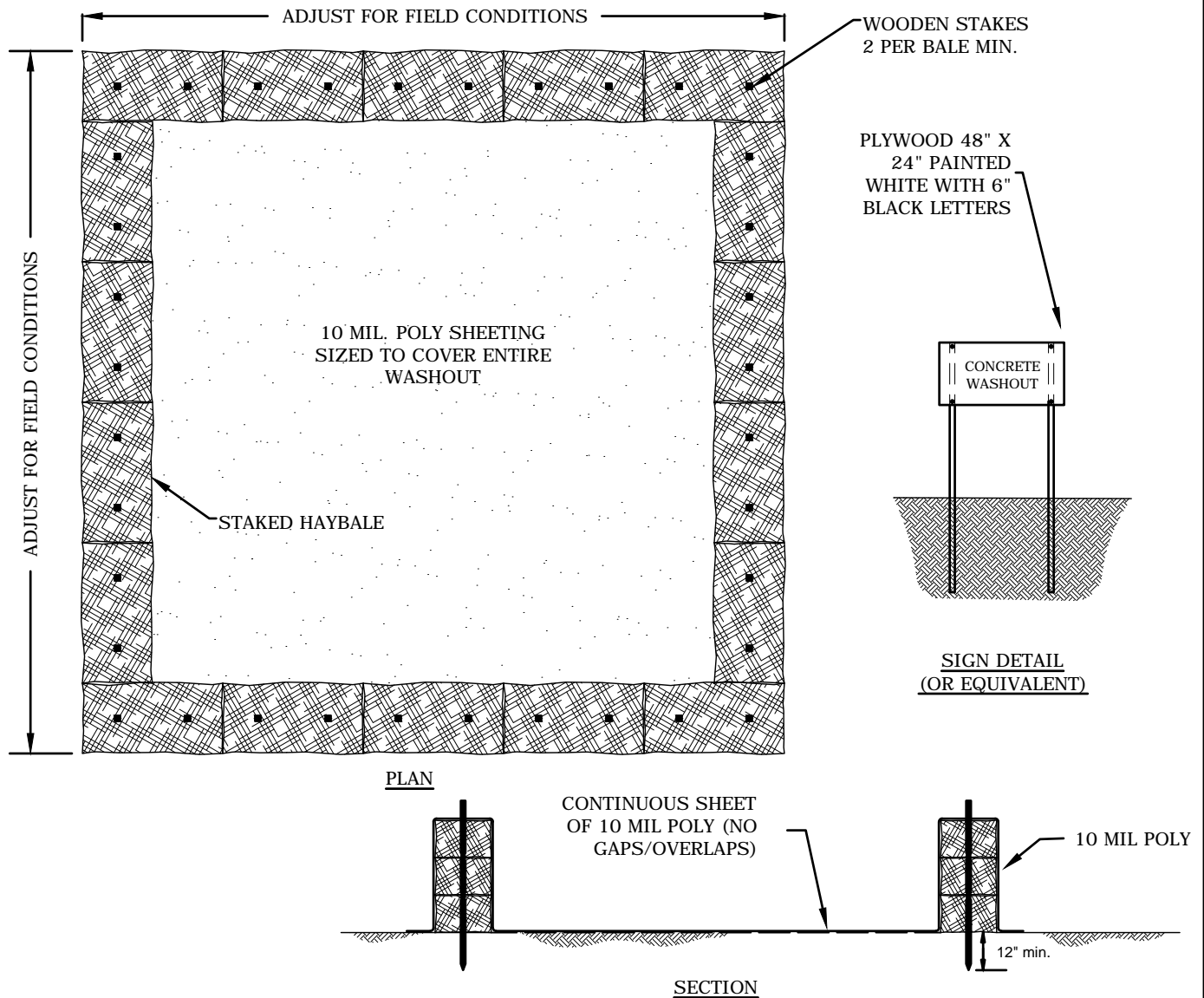

**NOTES:**

1. SIZE OF BASIN AND ASSOCIATED NUMBER OF BALES MAY VARY BASED ON SITE CONDITIONS.
2. THE BASIN SHALL BE SIZED TO PREVENT DISCHARGE WATER FROM OVERTOPPING BASIN. IF BASIN IS OVERTOPPED DISCONTINUE USE IMMEDIATELY AND RE-SIZE.
3. KEEP BASIN AS FAR FROM DRAINAGE CHANNELS/WETLANDS/SENSITIVE RESOURCES AS PRACTICAL (50FT MINIMUM)
4. BASINS SHALL BE LOCATED IN AREAS THAT ARE GENERALLY FLAT WITH SLOPES FROM 0-2%.
5. USE REINFORCED BASINS AS DETAILED WITH SILT FENCE AND STONE IN AREAS OF CONSIDERABLE FLOW AND FOR BASINS THAT ARE TO BE USED FOR PERIODS LONGER THAN 7 DAYS.
6. CLEAN AND REMOVE BASIN AS SOON AS CONCRETE WORK IS COMPLETE.
7. CONCRETE JERSEY BARRIERS CAN BE SUBSTITUTED FOR HAYBALES AS DESIRED.
8. SUMPS TO BE CLEANED AND WASTE CONCRETE REMOVED FOR PROPER DISPOSAL OF UPON COMPLETION OF WORK.



VERMONT ELECTRIC POWER COMPANY, INC.  
366 PINNACLE RIDGE ROAD  
RUTLAND, VERMONT 05701

## CONCRETE WASHOUT DETAIL

DATE: 08/2023

REV:

REF:

EPSC-17

# VELCO ENVIRONMENTAL GUIDANCE MANUAL

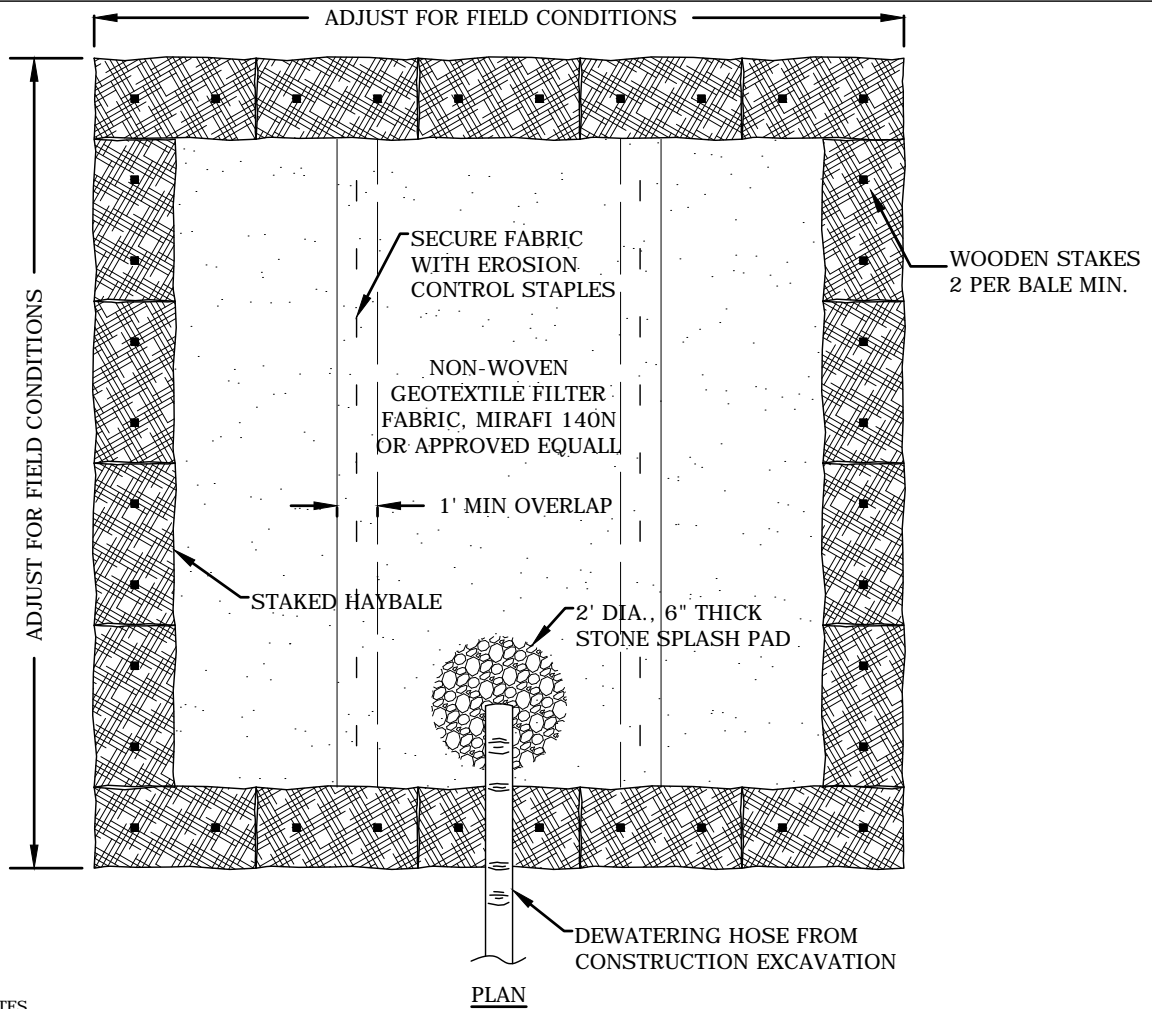

**NOTES**

1. SIZE OF BASIN AND ASSOCIATED NUMBER OF BALES MAY VARY BASED ON SITE CONDITIONS.
2. THE BASIN SHALL BE SIZED TO PREVENT DISCHARGE WATER FROM OVERTOPPING BASIN. IF BASIN IS OVERTOPPED DISCONTINUE USE IMMEDIATELY AND RE-SIZE.
3. KEEP BASIN AS FAR FROM WETLANDS/SENSITIVE RESOURCES AS PRACTICAL (50FT MINIMUM)
4. BASINS SHALL BE LOCATED IN AREAS THAT ARE GENERALLY FLAT WITH SLOPES FROM 0-2%.
5. USE REINFORCED BASINS AS DETAILED WITH SILT FENCE AND STONE IN AREAS OF CONSIDERABLE FLOW AND FOR BASINS THAT ARE TO BE USED FOR PERIODS LONGER THAN 7 DAYS.
6. CLEAN AND REMOVE BASIN AS SOON AS DEWATERING IS COMPLETE.
7. CONCRETE JERSEY BARRIERS CAN BE SUBSTITUTED FOR HAYBALES AS DESIRED.

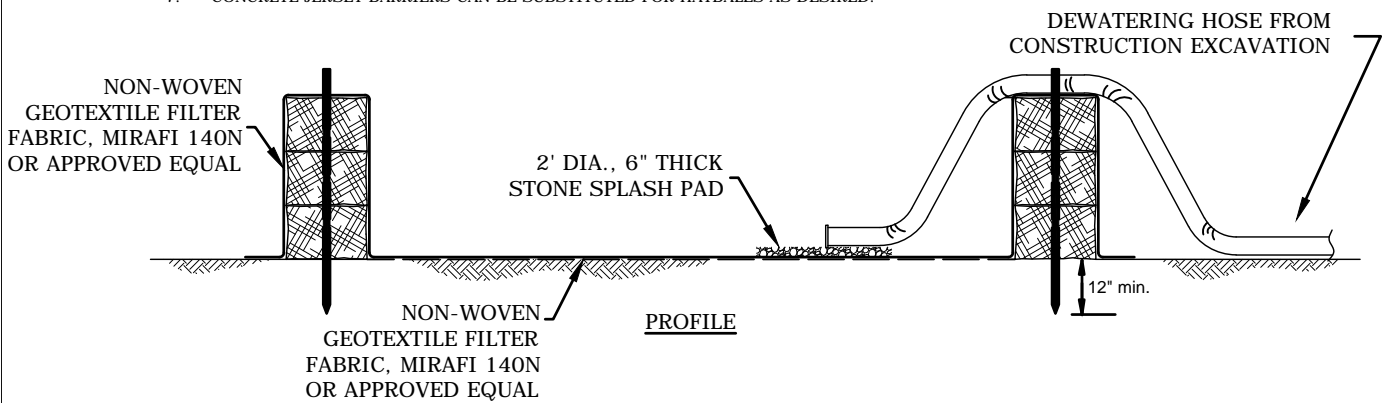

VERMONT ELECTRIC POWER COMPANY, INC.  
366 PINNACLE RIDGE ROAD  
RUTLAND, VERMONT 05701

## DEWATERING BASIN DETAIL

DATE: 08/2023

REV:

REF:

EPSC-18

# VELCO ENVIRONMENTAL GUIDANCE MANUAL

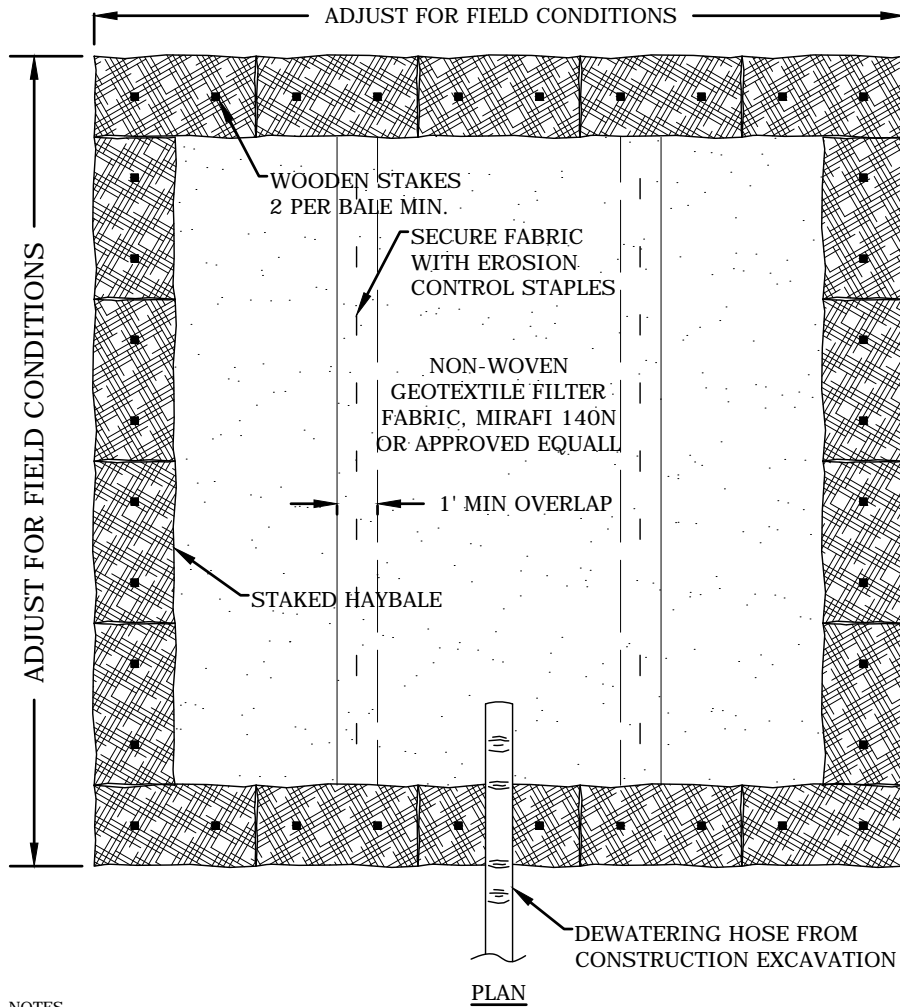

**NOTES**

1. SIZE OF BASIN AND ASSOCIATED NUMBER OF BALES MAY VARY BASED ON SITE CONDITIONS.
2. THE BASIN SHALL BE SIZED TO PREVENT DISCHARGE WATER FROM OVERTOPPING BASIN. IF BASIN IS OVERTOPPED DISCONTINUE USE IMMEDIATELY AND RE-SIZE.
3. KEEP BASIN AS FAR FROM WETLANDS/SENSITIVE RESOURCES AS PRACTICAL (50FT MINIMUM)
4. BASINS SHALL BE LOCATED IN AREAS THAT ARE GENERALLY FLAT WITH SLOPES FROM 0-2%.
5. CLEAN AND REMOVE BASIN AS SOON AS DEWATERING IS COMPLETE.
6. CONCRETE JERSEY BARRIERS CAN BE SUBSTITUTED FOR HAYBALES AS DESIRED.

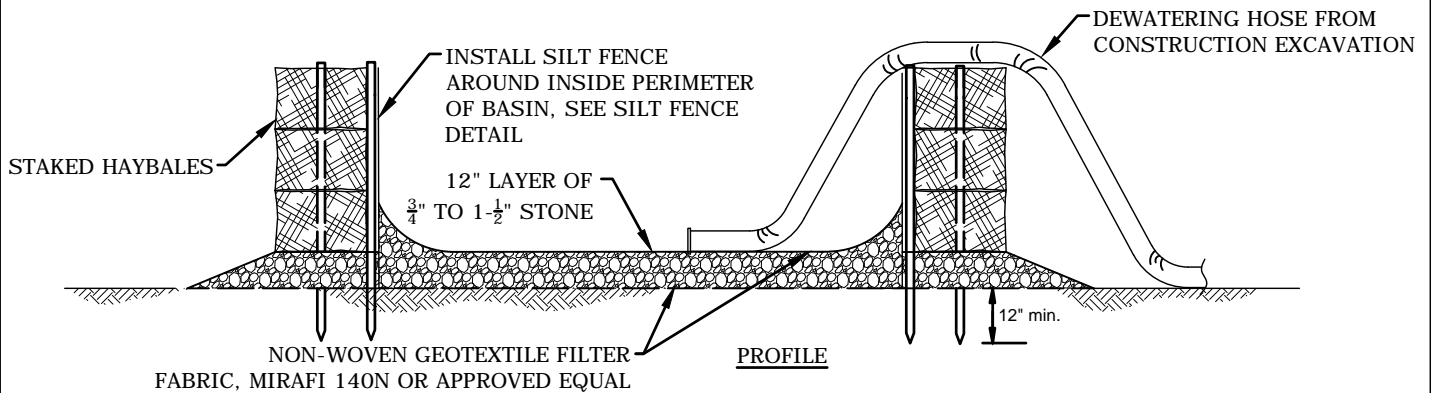

VERMONT ELECTRIC POWER COMPANY, INC.  
366 PINNACLE RIDGE ROAD  
RUTLAND, VERMONT 05701

## REINFORCED DEWATERING BASIN DETAIL

DATE: 08/2023

REV:

REF:

EPSC-19



# VELCO ENVIRONMENTAL GUIDANCE MANUAL

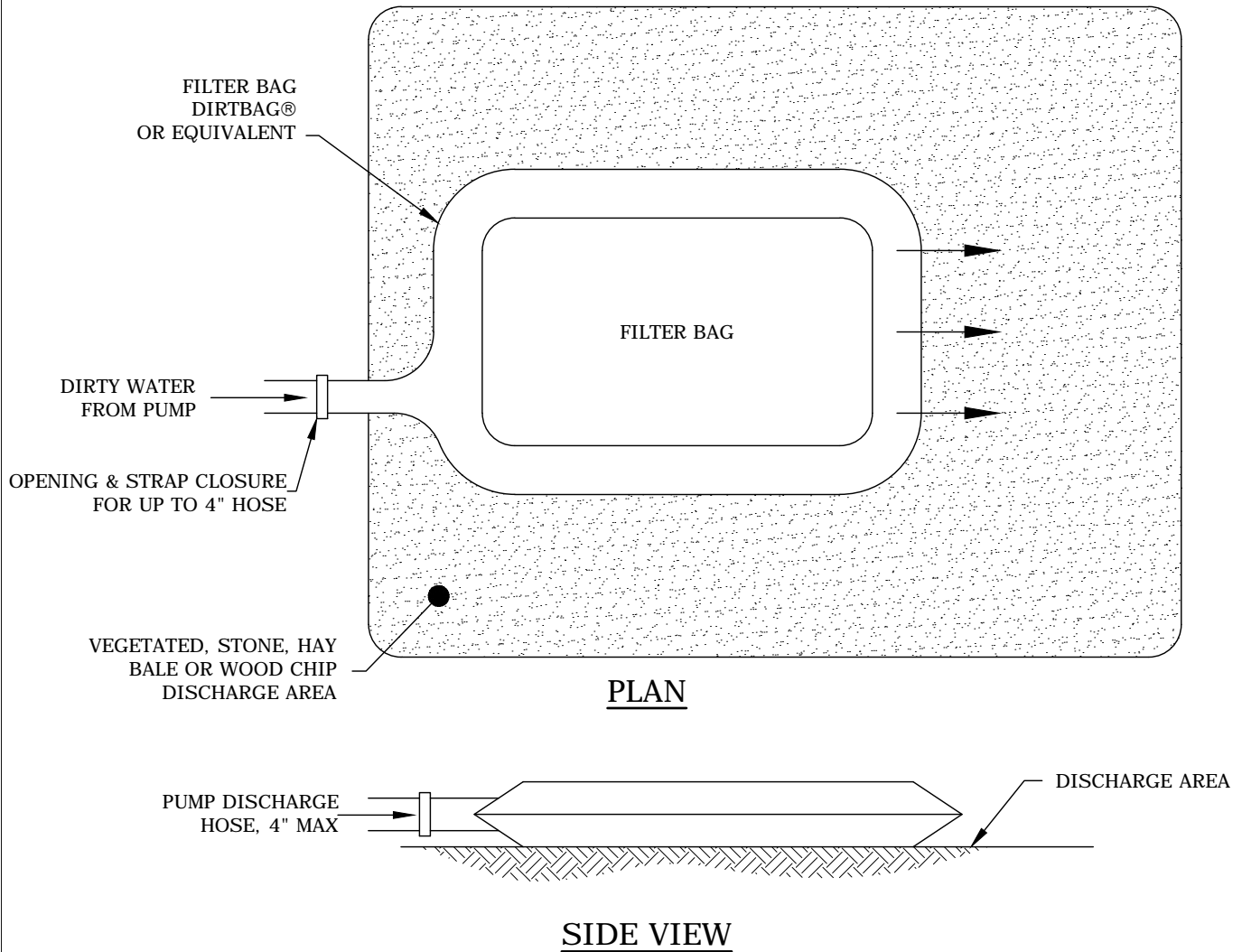

**NOTES:**

1. FILTER BAG SHALL BE PLACED IN A VEGETATED UPLAND AREA OR ATOP A DISCHARGE PAD CONSISTING OF STONE ( $\frac{3}{4}$ "-1  $\frac{1}{2}$ " ), WOOD CHIPS, OR HAY BALES.
2. LOCATE DISCHARGE SITE ON WELL DRAINED UPLAND AREA AT LEAST 50' FROM STREAMS, WETLANDS, AND OTHER RESOURCES AND POINTS OF CONCENTRATED FLOW, UNLESS OTHERWISE APPROVED. UNDER CERTAIN CIRCUMSTANCES IT MAY BE FEASIBLE TO UTILIZE A FILTER BAG PLACED WITHIN DEWATERING BASIN.
3. SELECTION OF FILTER BAG MATERIAL BASED ON PARTICLE SIZE IN DIRTY WATER, I.E. FOR COARSE PARTICLES A WOVEN MATERIAL; FOR SILTS/CLAYS A NON-WOVEN MATERIAL.
4. ALL HOSES AND FITTINGS SHOULD BE SECURED TIGHTLY PRIOR TO USE. DO NOT OVER PRESSURIZE FILTER BAG OR USE BEYOND CAPACITY.
5. DOWNGRAIDENT RECEIVING AREA MUST BE WELL VEGETATED OR OTHERWISE STABLE FROM EROSION, E.G. FOREST FLOOR OR COARSE GRAVEL/STONE.



VERMONT ELECTRIC POWER COMPANY, INC.  
366 PINNACLE RIDGE ROAD  
RUTLAND, VERMONT 05701

## FILTER BAG DEWATERING DETAIL

DATE: 08/2023

REV:

REF:

EPSC-20

# VELCO ENVIRONMENTAL GUIDANCE MANUAL

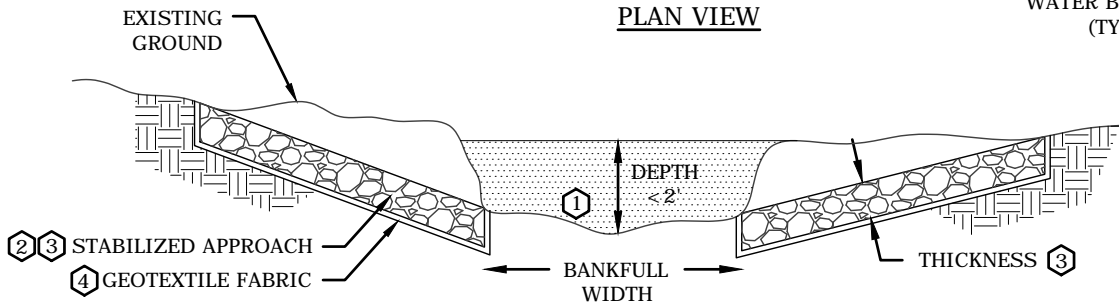
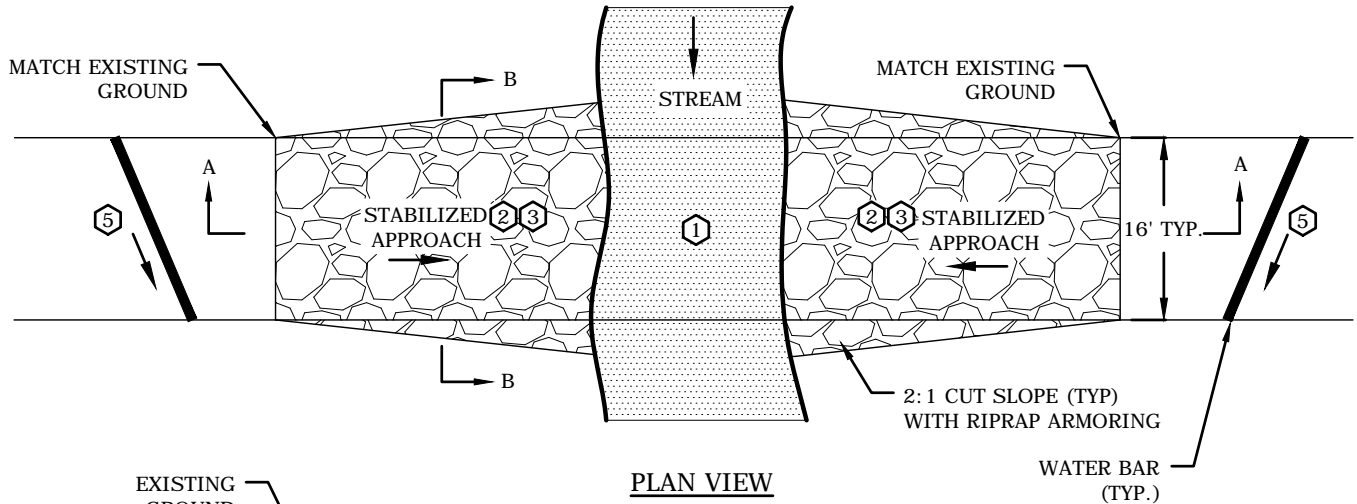

### SECTION A-A

**GENERAL NOTES:**

1. USE FORD CROSSING WHEN CHANNEL DEPTH IS 2 FEET OR LESS AND CONSTRUCTION OF REQUIRED APPROACH SLOPE IS FEASIBLE. CROSSINGS SHALL BE LOCATED IN AREAS WHERE THE NORMAL FLOW DEPTH IS SHALLOW (E.G. AT RIFFLES). AVOID LOCATING CROSSING AT POOLS.
2. ACCESS ROAD APPROACH SHALL BE APPROXIMATELY PERPENDICULAR TO STREAMBED.
3. APPROACH SLOPE SHALL BE GRADED AT 4H: 1V OR LESS.
4. STREAMBANK CUT SIDE SLOPES SHALL BE GRADED AT 2H: 1V OR LESS AND ARMORED WITH RIPRAP.
5. CONSTRUCT IN DRY CHANNEL. UTILIZE DAM & PUMP/FLUME METHOD AS NEEDED.
6. DURING TIMES OF HEAVY CONSTRUCTION TRAFFIC, UTILIZING CONSTRUCTION MATS SHOULD BE EVALUATED.

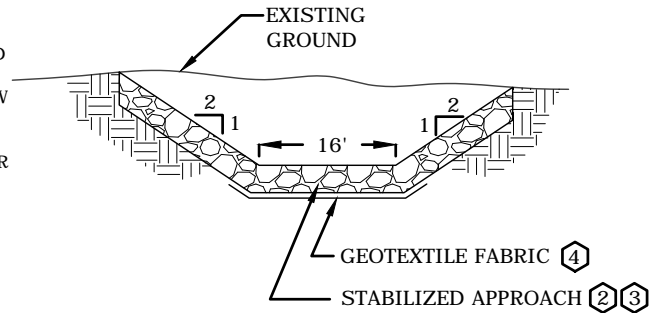

### SECTION B-B

**UNIMPROVED FORD CROSSING NOTES:**

1. UNIMPROVED AT-GRADE FORD CROSSINGS MAY BE USED WHEN EXISTING CHANNEL HAS A HARD, ROCKY SUBSTRATE.
2. STABILIZE APPROACH AND STREAMBANK WITH RIPRAP.
3. RIPRAP DESIGN IS BASED ON STREAM VELOCITY AT BANK-FULL FLOW. SEE "STREAM CROSSING DESIGN CALCULATIONS: FORD" SPREADSHEET FOR SITE SPECIFIC CALCULATIONS. MINIMUM THICKNESS IS 6 INCHES OVER GEOTEXTILE.
4. GEOTEXTILE SHALL BE MIRAFI 180N OR APPROVED EQUAL.
5. CONSTRUCT A WATERBAR ON BOTH SIDES OF THE CROSSING TO DIVERT SURFACE RUNOFF AWAY FROM THE APPROACH TO A STABLE, VEGETATED AREA.



VERMONT ELECTRIC POWER COMPANY, INC.  
366 PINNACLE RIDGE ROAD  
RUTLAND, VERMONT 05701

## UNIMPROVED FORD CROSSING DETAIL

DATE: 08/2023

REV:

REF:

CRS-1

# VELCO ENVIRONMENTAL GUIDANCE MANUAL

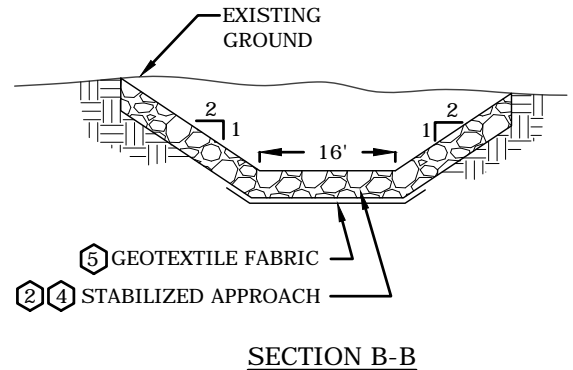
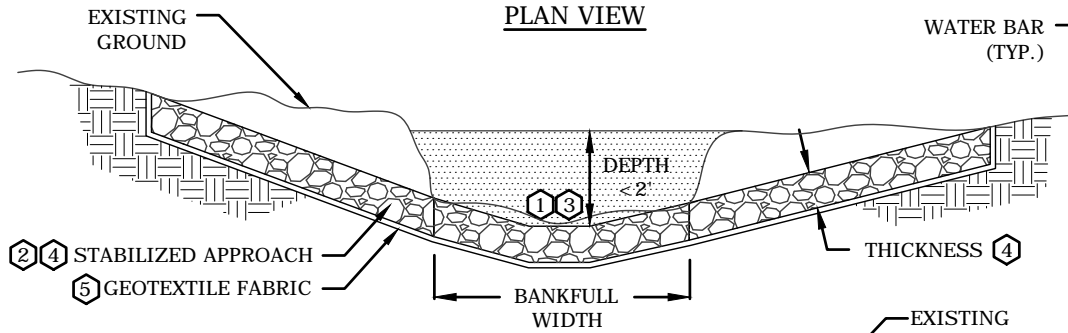
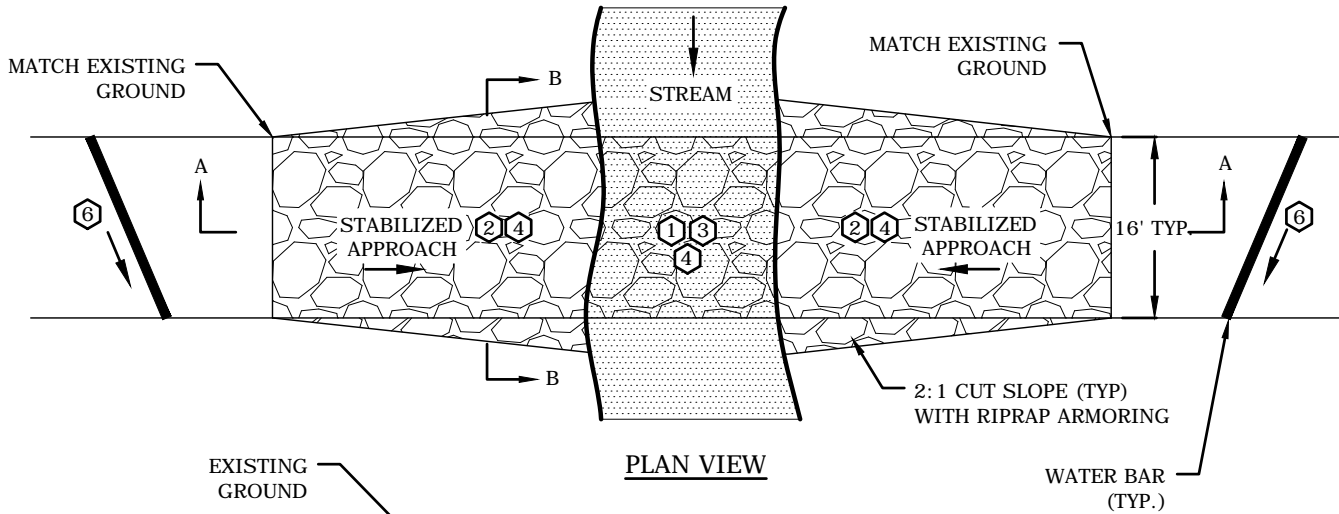

## GENERAL NOTES:

1. USE FORD CROSSING WHEN CHANNEL DEPTH IS 2 FEET OR LESS AND CONSTRUCTION OF REQUIRED APPROACH SLOPE IS FEASIBLE. CROSSINGS SHALL BE LOCATED IN AREAS WHERE THE NORMAL FLOW DEPTH IS SHALLOW (E.G AT RIFFLES). AVOID LOCATING CROSSINGS AT POOLS.
2. ACCESS ROAD APPROACH SHALL BE APPROXIMATELY PERPENDICULAR TO STREAMBED.
3. APPROACH SLOPE SHALL BE GRADED AT 4H: 1V OR LESS.
4. STREAMBANK CUT SIDE SLOPES SHALL BE GRADED AT 2H: 1V OR LESS AND ARMORED WITH RIPRAP.
5. CONSTRUCT IN DRY CHANNEL. UTILIZE DAM & PUMP/FLUME METHOD AS NEEDED.
6. DURING TIMES OF HEAVY CONSTRUCTION TRAFFIC, UTILIZING CONSTRUCTION MATS SHOULD BE EVALUATED.

## REINFORCED FORD CROSSING NOTES:

1. REINFORCED AT-GRADE FORD CROSSINGS MAY BE USED WHEN EXISTING CHANNEL HAS A SOFT OR UNSTABLE SUBSTRATE.
2. STABILIZE STREAM BED, APPROACH, AND STREAMBANK WITH RIPRAP.
3. THE FINISHED SURFACE OF THE FORD CROSSING SHALL BE NO HIGHER THAN THE EXISTING STREAM BED.
4. RIPRAP DESIGN IS BASED ON STREAM VELOCITY AT BANK-FULL FLOW. SEE "STREAM CROSSING DESIGN CALCULATIONS: FORD" SPREADSHEET FOR SITE SPECIFIC CALCULATIONS. MINIMUM THICKNESS IS 6 INCHES.
5. GEOTEXTILE SHALL BE MIRAFI 180N OR APPROVED EQUAL.
6. CONSTRUCT A WATERBAR ON BOTH SIDES OF THE CROSSING TO DIVERT SURFACE RUNOFF AWAY FROM THE APPROACH TO A STABLE, VEGETATED AREA.
7. UPON COMPLETION ASSURE SURFACE FLOW (SUBSURFACE FLOW UNACCEPTABLE).
8. INFILL MATERIAL SHALL BE ANR E-STONE TYPE FILL OR EQUIVALENT AS REFERENCED IN THE ANR STREAM BED STONE FILL DESIGN GUIDANCE.



VERMONT ELECTRIC POWER COMPANY, INC.  
366 PINNACLE RIDGE ROAD  
RUTLAND, VERMONT 05701

## IMPROVED FORD CROSSING DETAIL

DATE: 08/2023

REV:

REF:

CRS-2

# VELCO ENVIRONMENTAL GUIDANCE MANUAL

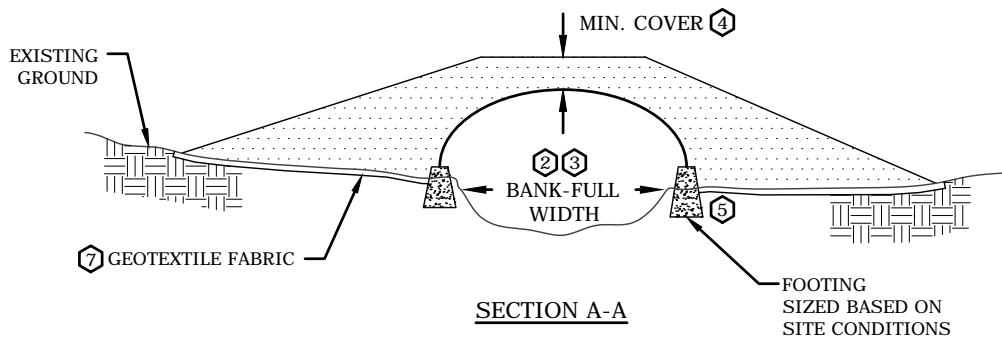
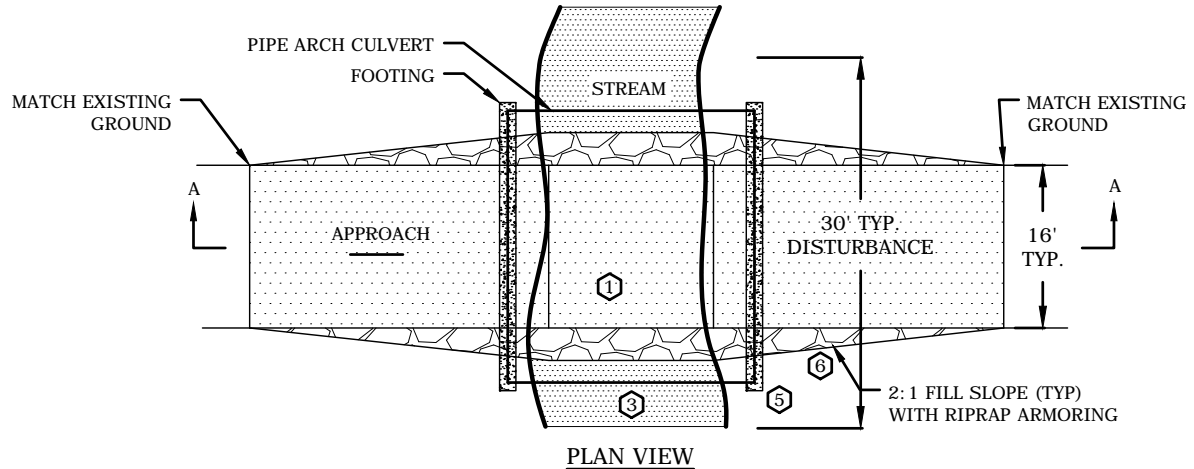

## GENERAL NOTES:

1. USE OPEN BOTTOM PIPE ARCH CULVERTS FOR ALL NEW CROSSINGS WHERE FORDS, BRIDGES, OR EMBEDDED CIRCULAR CULVERTS ARE NOT APPROPRIATE.
2. ACCESS ROAD APPROACH SHALL BE APPROXIMATELY PERPENDICULAR TO STREAMBED.
3. APPROACH SLOPE SHALL BE GRADED AT 4H: 1V OR LESS.
4. FILL SLOPES SHALL BE GRADED AT 2H: 1V OR LESS AND ARMORED WITH RIPRAP.
5. IF WORK IN CHANNEL IS REQUIRED, CONSTRUCT IN DRY CHANNEL. UTILIZE DAM & PUMP/FLUME METHOD AS NEEDED.

## PIPE ARCH CULVERT CROSSING NOTES:

1. ALIGN CULVERT WITH STREAM CHANNEL AS CLOSELY AS POSSIBLE. LIMITED CHANNEL RE-ALIGNMENT AT CROSSING MAY BE REQUIRED.
2. FOR STREAMS WITH WATERSHEDS GREATER THAN 1 SQ. MI. UPSTREAM OF THE POINT OF CROSSING, CULVERT CROWN SHALL BE  $Q_{25}$  HEADWATER ELEVATION PLUS 1 FOOT (MIN).
3. CULVERT SPAN SHALL BE AT LEAST 1.2 TIMES BANK-FULL STREAM WIDTH (MIN) IN ACCORDANCE WITH ACOE STREAM CROSSING BMPS.
4. MINIMUM COVER OVER CULVERT VARIES WITH CULVERT SIZE. CONSTRUCT PER MANUFACTURER SPECIFICATIONS. IF POSSIBLE, HIGH POINT OF CROSSING SHOULD BE 2 FEET (MIN.) ABOVE EXISTING GROUND ON EITHER SIDE OF CROSSING.
5. FOOTINGS MAY REQUIRE SITE-SPECIFIC ENGINEERING DESIGN WHEN CONCRETE WASTE BLOCKS CANNOT BE UTILIZED. PIPE SLOPE MUST MATCH BED SLOPE AT THE CROSSING.
6. RIPRAP DESIGN IS BASED ON STREAM VELOCITY AT BANK-FULL FLOW. SEE "STREAM CROSSING DESIGN CALCULATIONS: CULVERT" SPREADSHEET FOR SITE SPECIFIC CALCULATIONS. CONSTRUCT HEADWALL WITH NATIVE STONES IF AVAILABLE IN WORK AREA.
7. GEOTEXTILE SHALL BE MIRAFI 180N OR APPROVED EQUAL.
8. UPON COMPLETION ASSURE SURFACE FLOW (SUBSURFACE FLOW UNACCEPTABLE).
9. INFILL MATERIAL SHALL BE ANR E-STONE TYPE FILL OR EQUIVALENT AS REFERENCED IN THE ANR STREAM BED STONE FILL DESIGN GUIDANCE.



VERMONT ELECTRIC POWER COMPANY, INC.  
366 PINNACLE RIDGE ROAD  
RUTLAND, VERMONT 05701

## OPEN BOTTOM PIPE ARCH CULVERT DETAIL

DATE: 08/2023

REV:

REF:

CRS-3

# VELCO ENVIRONMENTAL GUIDANCE MANUAL

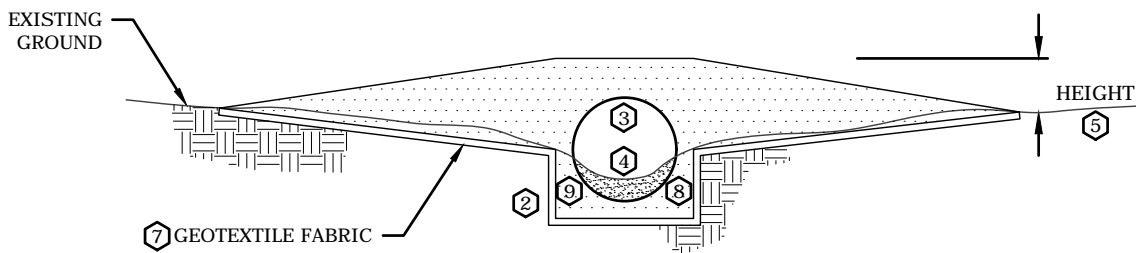
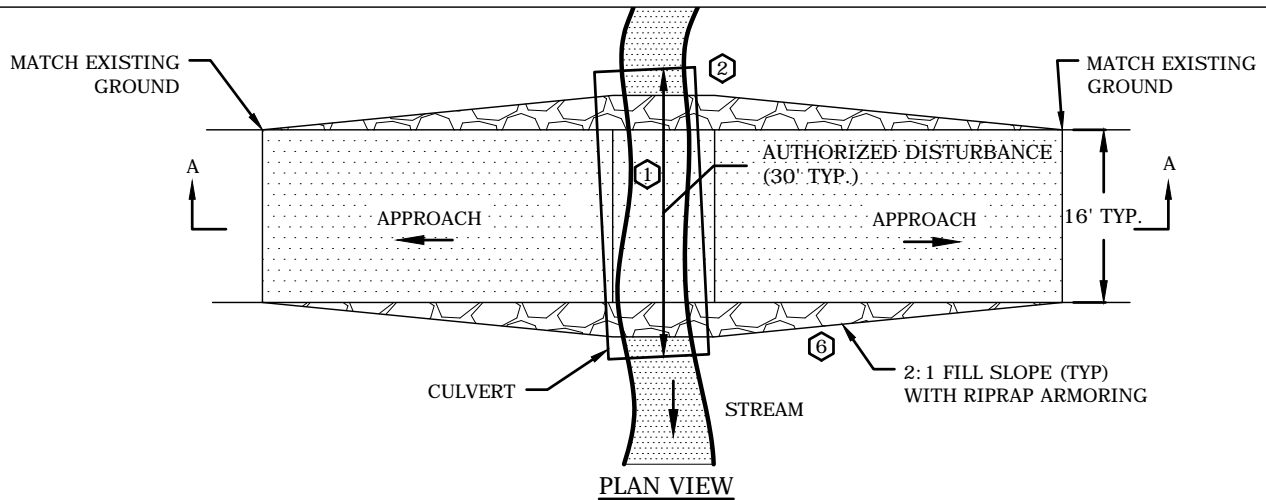

## GENERAL NOTES:

## SECTION A-A

1. INSTALL EMBEDDED CULVERT CROSSING WHEN CHANNEL DEPTH EXCEEDS 2 FEET, OR WHEN CHANNEL IS DEEPLY INCISED (UNSUITABLE FOR A FORD CROSSING, AND BRIDGE OR OPEN BOTTOM PIPE ARCH CULVERT INSTALLATION IS IMPRACTICAL OR UNSAFE).
2. ACCESS ROAD APPROACH SHALL BE APPROXIMATELY PERPENDICULAR TO STREAMBED.
3. APPROACH SLOPE SHALL BE GRADED AT 4H: 1V OR LESS.
4. CULVERT CROSSING SHALL BE CONSTRUCTED WITH MINIMUM COVER OF 1 FOOT CRUSHED AGGREGATE.
5. FILL SLOPES SHALL BE GRADED AT 2H: 1V OR LESS AND ARMORED WITH RIPRAP.
6. CONSTRUCT IN DRY CHANNEL. UTILIZE DAM & PUMP/FLUME METHOD AS NEEDED.

## CIRCULAR CULVERT CROSSING NOTES:

1. ALIGN CULVERT WITH STREAM CHANNEL AS CLOSELY AS POSSIBLE. LIMITED CHANNEL RE-ALIGNMENT AT CROSSING MAY BE REQUIRED
2. MINIMUM CULVERT WIDTH AT THE ELEVATION IT MEETS THE STREAM BED SHALL BE 1.2 TIMES THE AVERAGE NATURAL CHANNEL BANK-FULL WIDTH (MIN) IN ACCORDANCE WITH THE ACOE STREAM CROSSING BMPS.
3. FOR STREAM WITH WATERSHEDS GREATER THAN 1 SQ. MI. UPSTREAM OF THE CROSSING, CULVERT CROWN SHALL BE  $Q_{25}$  HEADWATER ELEVATION PLUS 1 FOOT (MIN).
4. EMBED CULVERT 20% TO 40% OF THE DIAMETER, AND PIPE SLOPE MUST MATCH BED SLOPE AT THE CROSSING. IF CHANNEL SLOPE IS GREATER THAN 1%, CONSTRUCT BED AND BANK WITHIN CULVERT. FLOWS SHOULD MATCH SLOPE OF CHANNEL AND BE ON SURFACE AFTER CONSTRUCTION. INFILL OR EMBEDMENT MATERIAL SHALL BE NATIVE STREAMBED MATERIAL OR ANR SPEC.
5. MINIMUM COVER OVER CULVERT VARIES WITH CULVERT SIZE. IF POSSIBLE, HIGH POINT OF CROSSING SHOULD BE 2 FEET (MIN.) ABOVE EXISTING GROUND ON EITHER SIDE OF CROSSING.
6. RIPRAP DESIGN IS BASED ON STREAM VELOCITY AT BANK-FULL FLOW. SEE "STREAM CROSSING DESIGN CALCULATIONS: CULVERT" SPREADSHEET FOR SITE SPECIFIC CALCULATIONS. CONSTRUCT HEADWALL WITH NATIVE STONES IF AVAILABLE IN WORK AREA.
7. GEOTEXTILE SHALL BE MIRAFI 180N OR APPROVED EQUAL.
8. UPON COMPLETION ASSURE SURFACE FLOW (SUBSURFACE FLOW UNACCEPTABLE).
9. INFILL MATERIAL SHALL BE ANR E-STONE TYPE FILL OR EQUIVALENT AS REFERENCED IN THE ANR STREAM BED STONE FILL DESIGN GUIDANCE.



VERMONT ELECTRIC POWER COMPANY, INC.  
366 PINNACLE RIDGE ROAD  
RUTLAND, VERMONT 05701

## EMBEDDED CULVERT DETAIL FOR STREAM CROSSING

DATE: 08/2023

REV:

REF:

CRS-4

# VELCO ENVIRONMENTAL GUIDANCE MANUAL

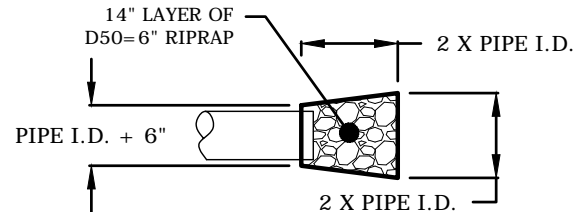
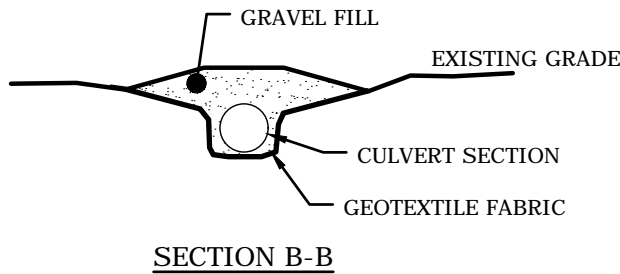
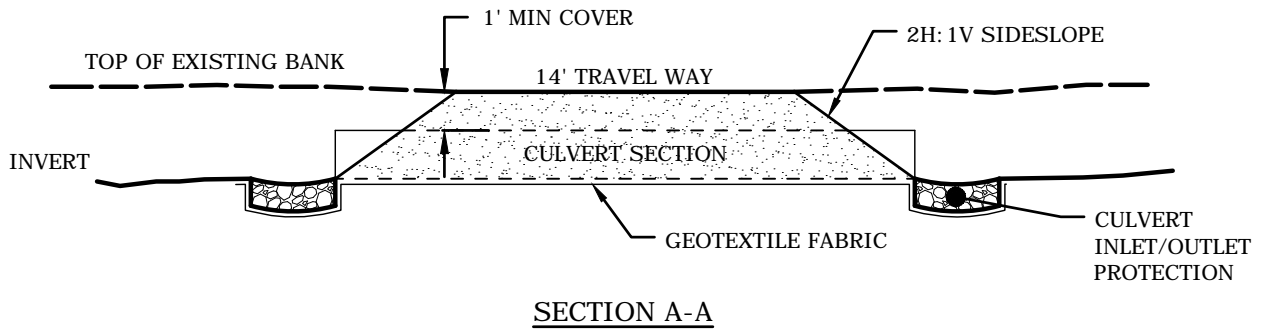
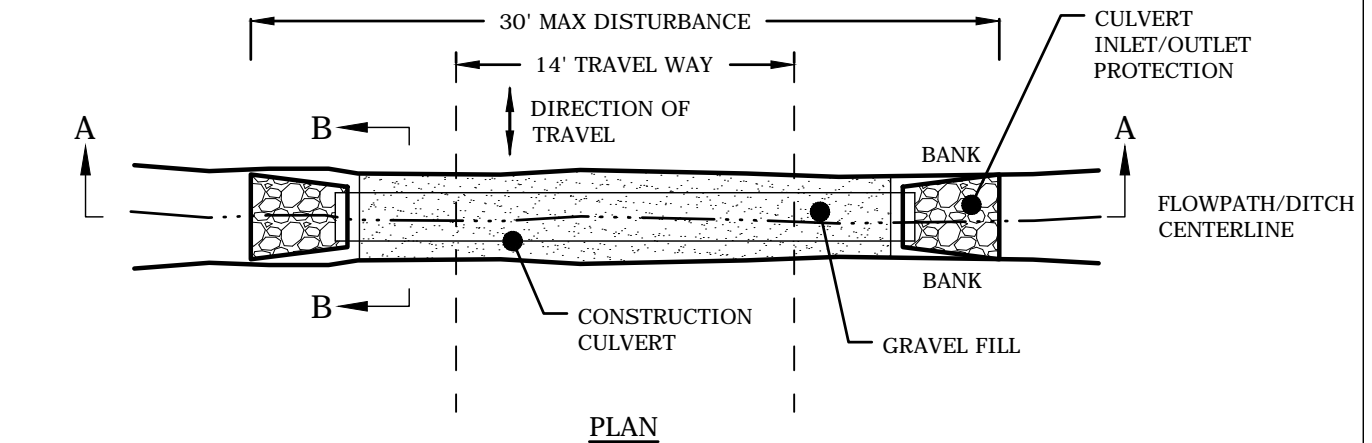

**NOTES:**

1. CULVERT SIZE SHOULD BE BASED UPON THE WIDTH OF THE FLOW PATH OR DITCH. THE MINIMUM CULVERT SIZE SHALL BE AN 18-INCH DIAMETER PIPE.
2. CULVERT LENGTH: THE CULVERTS SHALL EXTEND A MINIMUM OF ONE FOOT BEYOND THE TOE OF SLOPE ON EITHER SIDE OF THE ROAD. IN NO CASE SHALL THE CULVERT EXCEED THE WIDTH NEEDED TO ACCESS THE WORK LOCATION WITH A SINGLE LANE.
3. THE INVERT ELEVATIONS OF THE CULVERT SHALL BE INSTALLED AT OR BELOW THE NATURAL FLOW PATH GRADE.
4. THE CULVERT SHALL BE COVERED WITH A MINIMUM ONE FOOT OF AGGREGATE. IF MULTIPLE CULVERTS ARE USED, THEY SHALL BE SEPARATED BY AT LEAST 12 INCHES OF COMPACTED AGGREGATE FILL.
5. INLET AND OUTLET PROTECTION IS TO BE INSTALLED AS DETAILED.
6. GEOTEXTILE FABRIC SHALL BE PLACED ON THE BED AND BANKS OF THE FLOWPATH OR DITCH PRIOR TO PLACEMENT OF THE PIPE AND AGGREGATE. THE FABRIC SHALL COVER THE FLOWPATH OR DITCH AND EXTEND A MINIMUM SIX INCHES AND A MAXIMUM ONE-FOOT BEYOND THE END OF THE CULVERT AND BEDDING MATERIAL.



VERMONT ELECTRIC POWER COMPANY, INC.  
366 PINNACLE RIDGE ROAD  
RUTLAND, VERMONT 05701

## NON-STREAM CULVERT DETAIL

DATE: 08/2023

REV:

REF:

CRS-5

# VELCO ENVIRONMENTAL GUIDANCE MANUAL

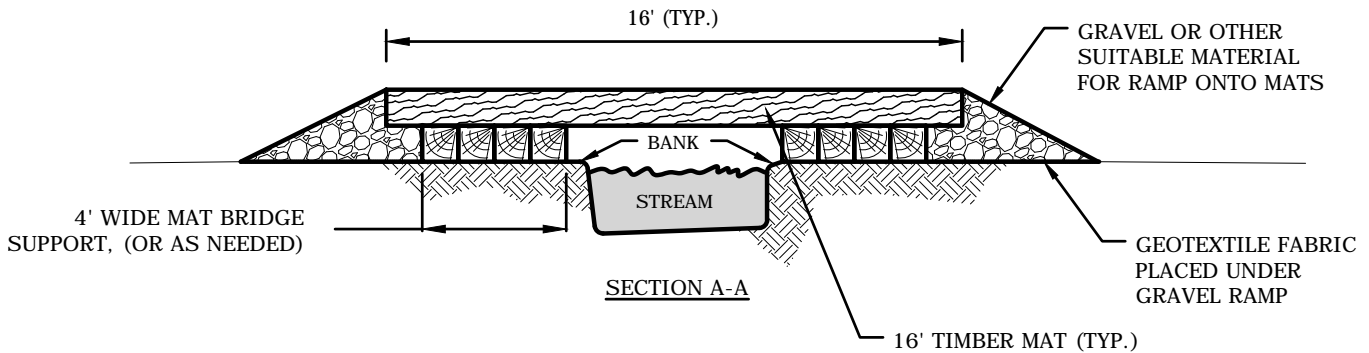
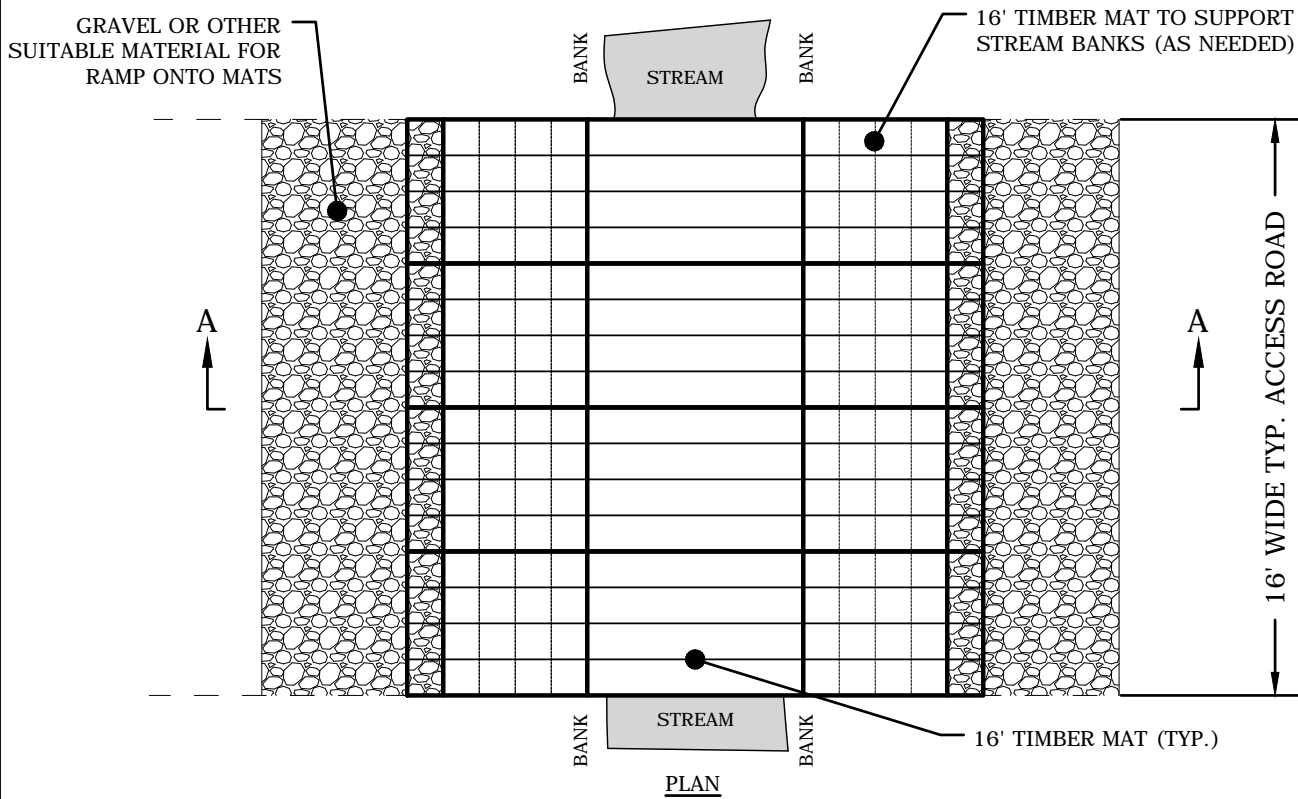

## NOTES

1. DEPLOY EROSION CONTROLS AS NEEDED TO MINIMIZE EROSION.
2. PERFORM ROUTINE INSPECTION TO INCLUDE REMOVAL OF LOOSE SOIL TRACKED ONTO BRIDGE BY EQUIPMENT AND INSPECTION OF STREAM BANKS FOR STABILITY.
3. MATS SHALL BE POSITIONED TO RETAIN THE NATURAL STREAM CHARACTERISTICS.
4. MATS LAID PERPENDICULAR TO THE STREAM CAN BE SUBSTITUTED WITH PRE-FABRICATED BRIDGE STRUCTURES AS SPAN LENGTHS DICTATE OR AT THE PREFERENCE OF THE CONTRACTOR.



VERMONT ELECTRIC POWER COMPANY, INC.  
366 PINNACLE RIDGE ROAD  
RUTLAND, VERMONT 05701

## TIMBER MAT BRIDGE DETAIL

DATE: 08/2023

REV:

REF:

CRS-6

# VELCO ENVIRONMENTAL GUIDANCE MANUAL

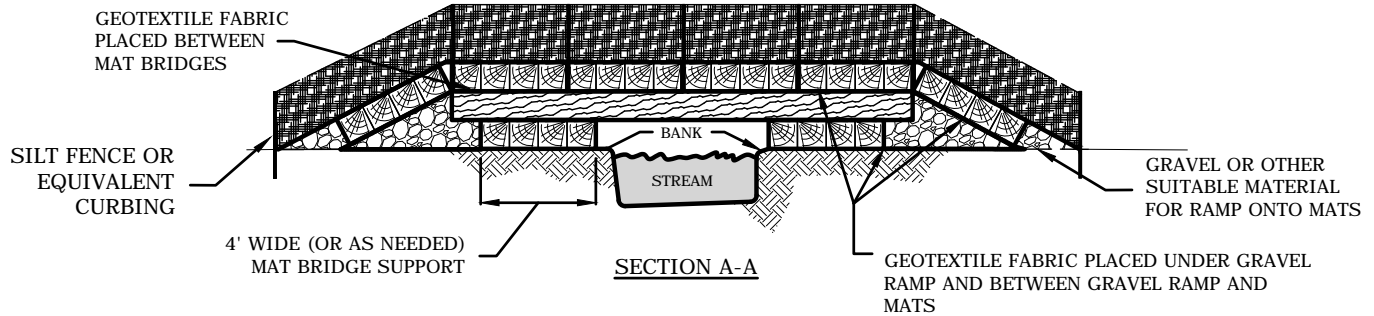
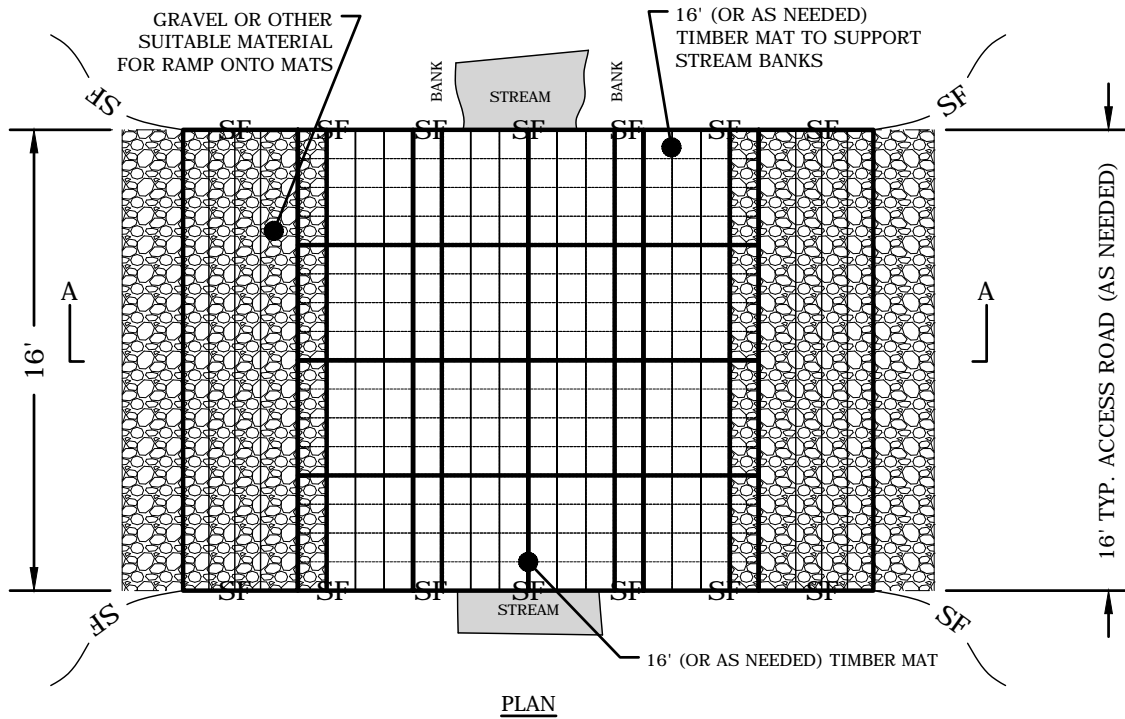

## NOTES

1. DEPLOY EROSION CONTROLS AS NEEDED TO MINIMIZE EROSION.
2. PERFORM ROUTINE INSPECTION TO INCLUDE REMOVAL OF LOOSE SOIL TRACKED ONTO BRIDGE BY EQUIPMENT AND INSPECTION OF STREAM BANKS FOR STABILITY.
3. MATS SHALL BE POSITIONED TO RETAIN THE NATURAL STREAM CHARACTERISTICS.
4. MATS LAID PERPENDICULAR TO THE STREAM CAN BE SUBSTITUTED WITH PRE-FABRICATED BRIDGE STRUCTURES AS SPAN LENGTHS DICTATE OR AT THE PREFERENCE OF THE CONTRACTOR.

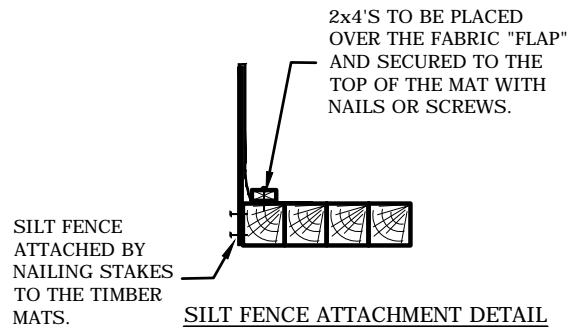

VERMONT ELECTRIC POWER COMPANY, INC.  
366 PINNACLE RIDGE ROAD  
RUTLAND, VERMONT 05701

## ALT. TIMBER MAT BRIDGE DETAIL

DATE: 08/2023

REV:

REF:

CRS-7



# VELCO ENVIRONMENTAL GUIDANCE MANUAL

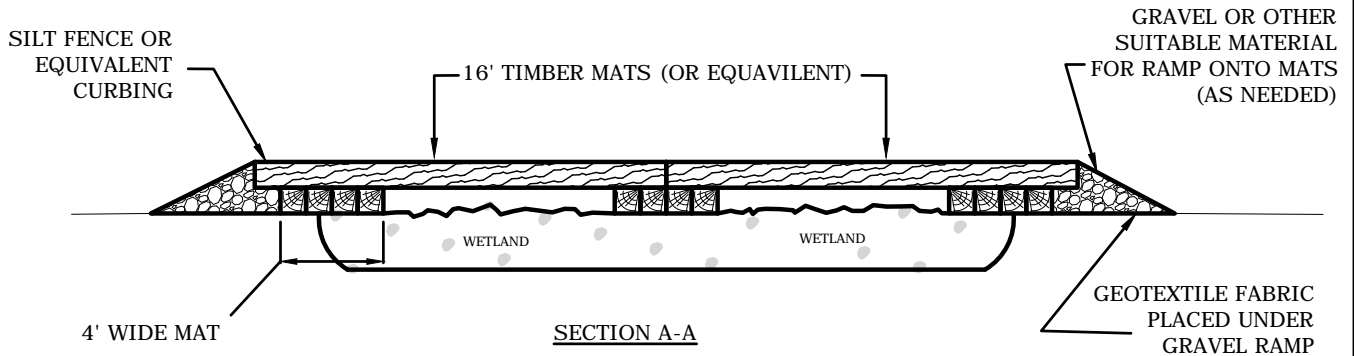
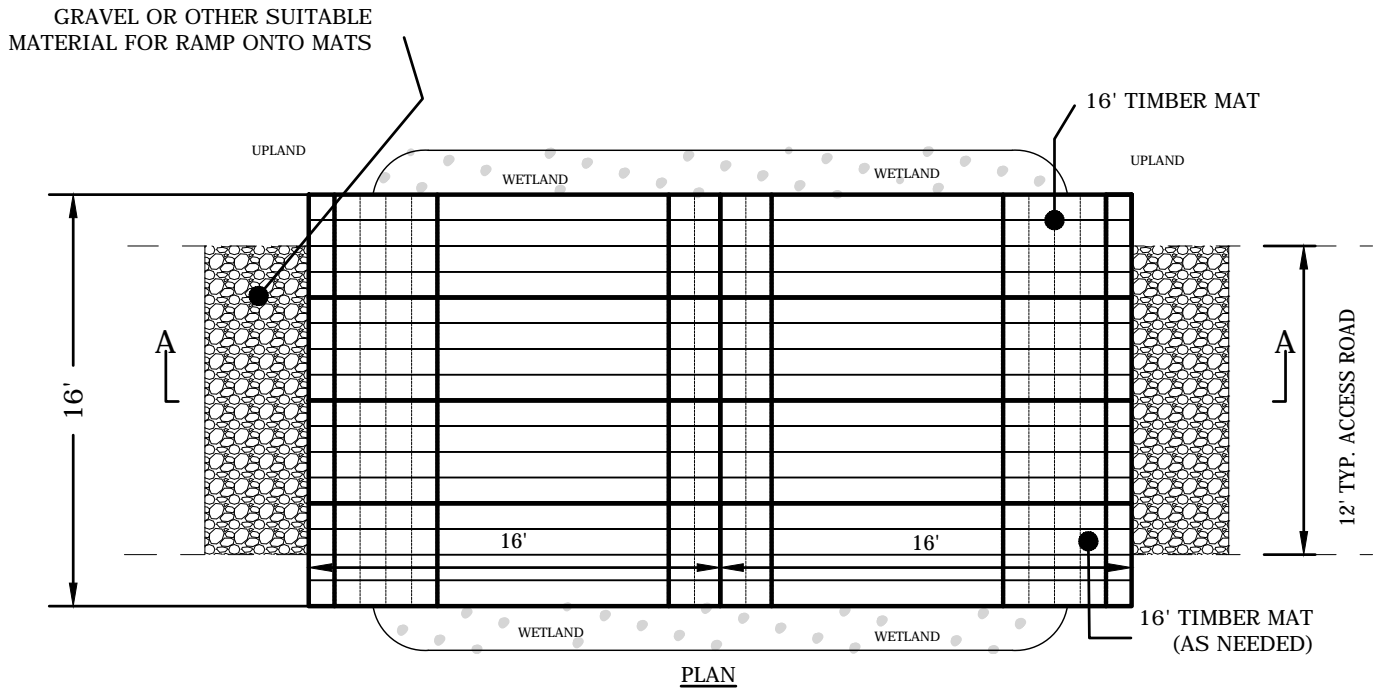

## NOTES

1. DEPLOY EROSION CONTROLS AS NEEDED TO MINIMIZE EROSION.
2. PERFORM ROUTINE INSPECTION TO INCLUDE REMOVAL OF LOOSE SOIL TRACKED ONTO MATS BY EQUIPMENT.
3. MATS SHALL BE POSITIONED TO RETAIN NATURAL FLOW CHARACTERISTICS.



VERMONT ELECTRIC POWER COMPANY, INC.  
366 PINNACLE RIDGE ROAD  
RUTLAND, VERMONT 05701

WETLAND TIMBER MATTING

DETAIL

DATE: 08/2023

REV:

REF:

CRS-8

# VELCO ENVIRONMENTAL GUIDANCE MANUAL

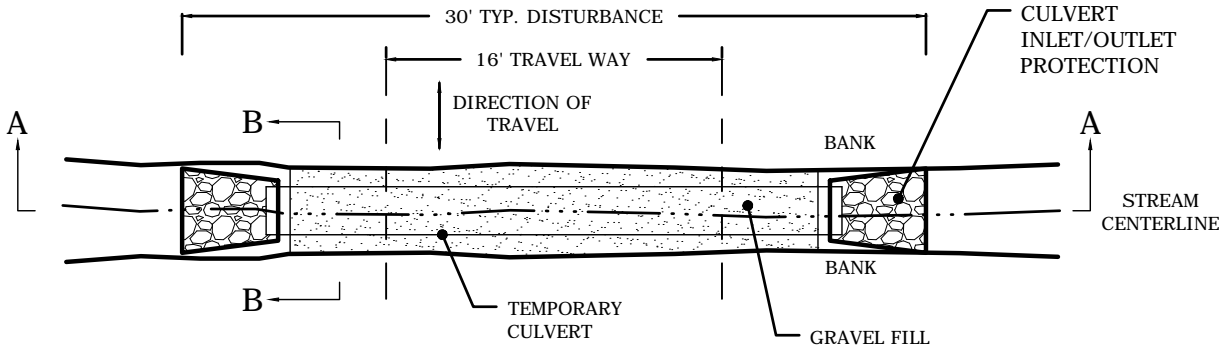

PLAN

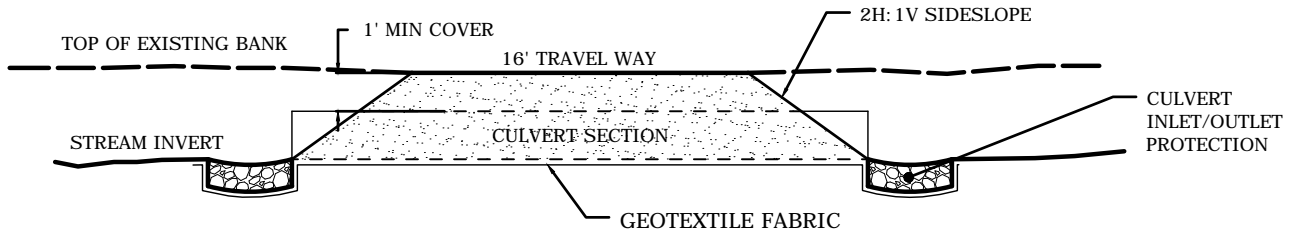

SECTION A-A

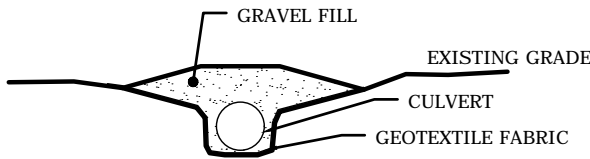

SECTION B-B

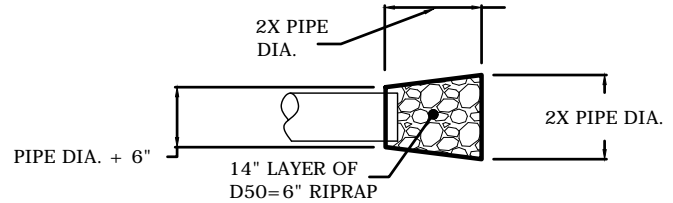

CULVERT INLET/OUTLET PROTECTION PLAN

NOTES:

1. CULVERT SIZE: THE CROSS SECTIONAL AREA OF THE CULVERT PIPE SHALL BE THE LARGEST PIPE DIAMETER EQUAL TO THE UNDISTURBED CROSS SECTIONAL AREA OF THE BANK FULL CONDITION OF THE STREAM. IT SHOULD FIT INTO THE EXISTING CHANNEL WITHOUT EXCAVATION OF THE WATERWAY CHANNEL OR MAJOR APPROACH FILLS. IF A CHANNEL WIDTH EXCEEDS 3 FEET, ADDITIONAL PIPES MAY BE USED UNTIL THE CROSS SECTIONAL AREA OF THE PIPES APPROACHES THE EXISTING CHANNEL. THE MINIMUM CULVERT SIZE SHALL BE AN 18-INCH DIAMETER PIPE.
2. CULVERT LENGTH: THE CULVERTS SHALL EXTEND A MINIMUM OF ONE FOOT BEYOND THE UPSTREAM AND DOWNSTREAM TOE OF THE AGGREGATE PLACED AROUND THE CULVERT. IN NO CASE SHALL THE CULVERT EXCEED THE WIDTH NEEDED TO ACCESS THE WORK LOCATION WITH A SINGLE LANE.
3. THE INVERT ELEVATIONS OF THE CULVERT SHALL BE INSTALLED AT OR BELOW THE NATURAL STREAMBED GRADE TO MINIMIZE INTERFERENCE WITH FISH MIGRATION.
4. THE CULVERT SHALL BE COVERED WITH A MINIMUM ONE FOOT OF AGGREGATE. IF MULTIPLE CULVERTS ARE USED, THEY SHALL BE SEPARATED BY AT LEAST 12 INCHES OF COMPACTED AGGREGATE FILL.
5. TEMPORARY INLET AND OUTLET PROTECTION IS TO BE INSTALLED AS DETAILED.
6. GEOTEXTILE FABRIC SHALL BE PLACED ON THE STREAMBED AND STREAMBANKS PRIOR TO PLACEMENT OF THE PIPE AND AGGREGATE. THE FABRIC SHALL COVER THE STREAMBED AND EXTEND A MINIMUM SIX INCHES AND A MAXIMUM ONE-FOOT BEYOND THE END OF THE CULVERT AND BEDDING MATERIAL.
7. CULVERT AND ALL ASSOCIATED MATERIALS SHOULD BE REMOVED UPON COMPLETION OF THE WORK.



VERMONT ELECTRIC POWER COMPANY, INC.  
366 PINNACLE RIDGE ROAD  
RUTLAND, VERMONT 05701

## TEMPORARY CULVERT DETAIL

DATE: 08/2023

REV:

REF:

CRS-9

# VELCO ENVIRONMENTAL GUIDANCE MANUAL

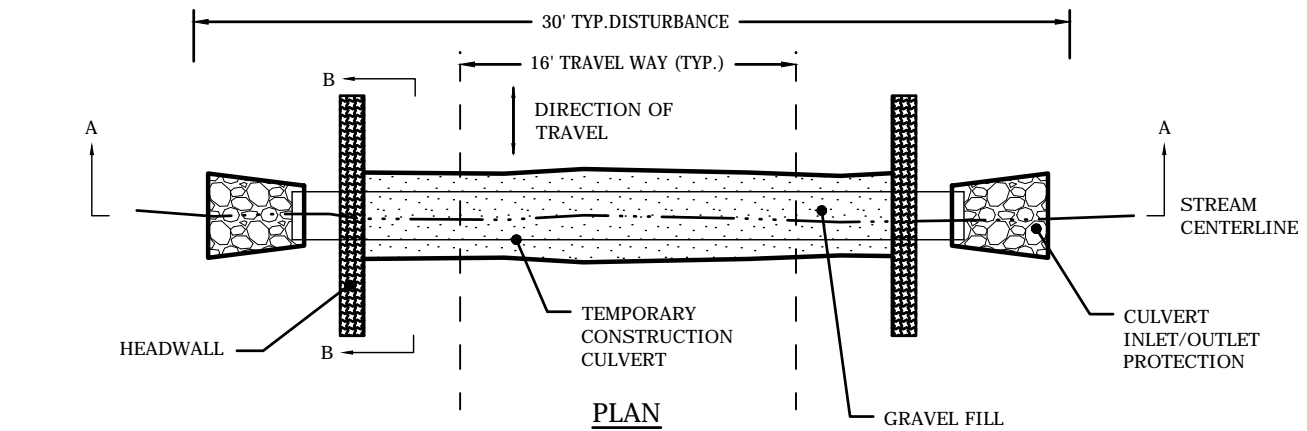

**PLAN**

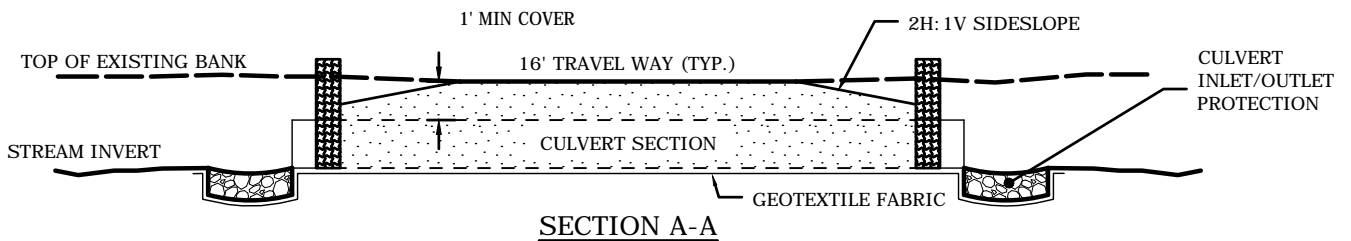

**SECTION A-A**

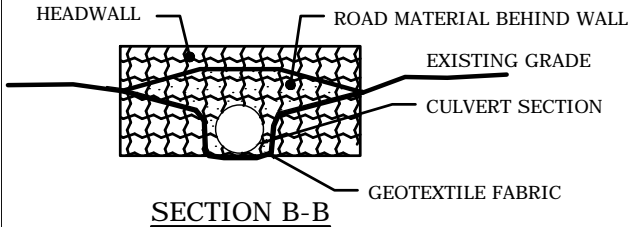

**SECTION B-B**

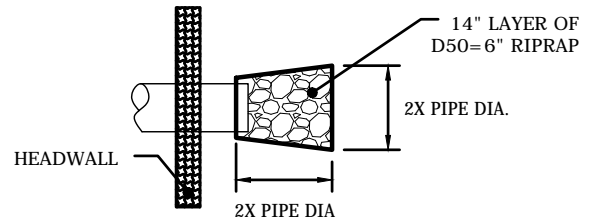

**CULVERT INLET/OUTLET PROTECTION PLAN**

**NOTES:**

1. CULVERT SIZE: THE CROSS SECTIONAL AREA OF THE CULVERT PIPE SHALL BE THE LARGEST PIPE DIAMETER EQUAL TO THE UNDISTURBED CROSS SECTIONAL AREA OF THE BANK FULL CONDITION OF THE STREAM. IT SHOULD FIT INTO THE EXISTING CHANNEL WITHOUT EXCAVATION OF THE WATERWAY CHANNEL OR MAJOR APPROACH FILLS. IF A CHANNEL WIDTH EXCEEDS 3 FEET, ADDITIONAL PIPES MAY BE USED UNTIL THE CROSS SECTIONAL AREA OF THE PIPES APPROACHES THE EXISTING CHANNEL. THE MINIMUM CULVERT SIZE SHALL BE AN 18-INCH DIAMETER PIPE.
2. CULVERT LENGTH: THE CULVERTS SHALL EXTEND A MINIMUM OF ONE FOOT BEYOND THE UPSTREAM AND DOWNSTREAM TOE OF THE AGGREGATE PLACED AROUND THE CULVERT. IN NO CASE SHALL THE CULVERT EXCEED THE WIDTH NEEDED TO ACCESS THE WORK LOCATION WITH A SINGLE LANE.
3. THE INVERT ELEVATIONS OF THE CULVERT SHALL BE INSTALLED AT OR BELOW THE NATURAL STREAMBED GRADE TO MINIMIZE INTERFERENCE WITH FISH MIGRATION.
4. THE CULVERT SHALL BE COVERED WITH A MINIMUM ONE FOOT OF AGGREGATE. IF MULTIPLE CULVERTS ARE USED, THEY SHALL BE SEPARATED BY AT LEAST 12 INCHES OF COMPACTED AGGREGATE FILL.
5. TEMPORARY INLET AND OUTLET PROTECTION IS TO BE INSTALLED AS DETAILED.
6. GEOTEXTILE FABRIC SHALL BE PLACED ON THE STREAMBED AND STREAMBANKS PRIOR TO PLACEMENT OF THE PIPE AND AGGREGATE. THE FABRIC SHALL COVER THE STREAMBED AND EXTEND A MINIMUM SIX INCHES AND A MAXIMUM ONE-FOOT BEYOND THE END OF THE CULVERT AND BEDDING MATERIAL.
7. HEADWALL NOTE: THE CULVERT HEADWALL SHALL BE CONSTRUCTED IN A MANNER THAT PRESERVES THE ORIGINAL STREAM OR DRAINAGE CHANNEL, AVOIDS IMPACTS TO REGULATED FEATURES (I.E WETLANDS, STREAMS), AND PRESERVES ROAD SHOULDER INTEGRITY AS IT RELATES TO STORMWATER EROSION AND THE ALLOWABLE ROAD WIDTH. HEADWALLS SHALL CONSIST OF EITHER SUITABLE, LOCAL MATERIALS (I.E BOULDERS, LOGS) OR APPROVED PRECAST CONCRETE BLOCKS, GABIONS, OR STONE.
8. TEMPORARY CULVERT AND ALL ASSOCIATED MATERIALS SHOULD BE REMOVED UPON COMPLETION OF THE WORK.



VERMONT ELECTRIC POWER COMPANY, INC.  
366 PINNACLE RIDGE ROAD  
RUTLAND, VERMONT 05701

## ALT. TEMPORARY CULVERT DETAIL

DATE: 08/2023

REV:

REF:

CRS-10

# VELCO ENVIRONMENTAL GUIDANCE MANUAL

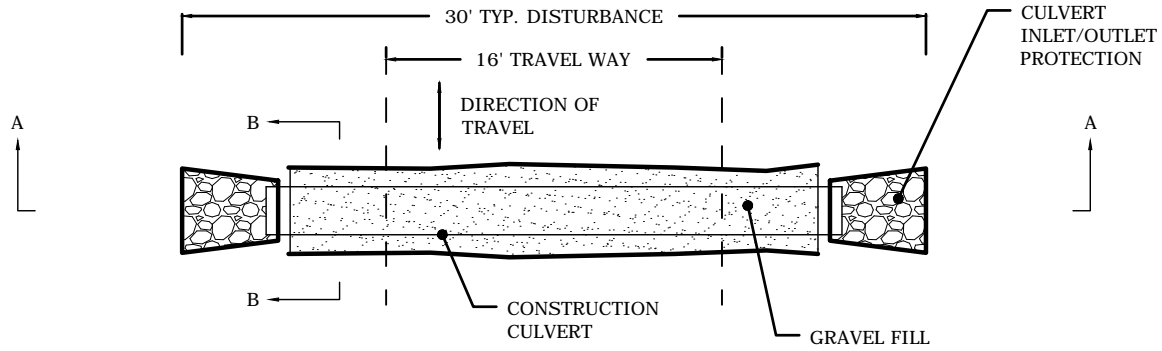

**PLAN**

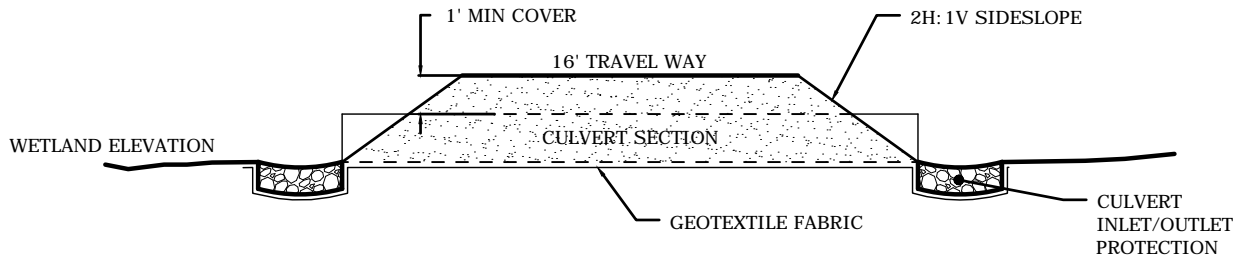

**SECTION A-A**

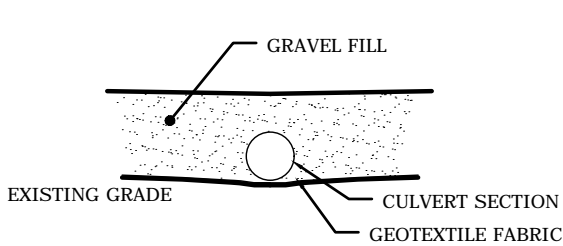

**SECTION B-B**

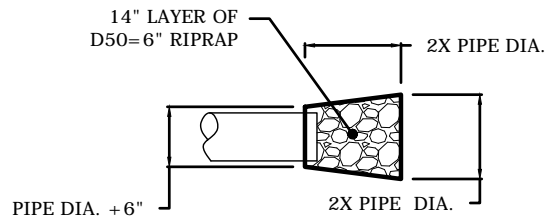

**CULVERT INLET/OUTLET PROTECTION PLAN**

**NOTES:**

1. CULVERT SIZE SHOULD BE BASED UPON THE HYDROLOGY OF THE WETLAND.
2. CULVERT LENGTH: THE CULVERTS SHALL EXTEND A MINIMUM OF ONE FOOT BEYOND THE TOE OF SLOPE ON EITHER SIDE OF THE ROAD. IN NO CASE SHALL THE CULVERT EXCEED THE WIDTH NEEDED TO ACCESS THE WORK LOCATION WITH A SINGLE LANE.
3. THE INVERT ELEVATIONS OF THE CULVERT SHALL BE INSTALLED AT OR BELOW THE EXISTING WETLAND GRADE TO PROMOTE CONNECTION.
4. THE CULVERT SHALL BE COVERED WITH A MINIMUM ONE FOOT OF AGGREGATE. IF MULTIPLE CULVERTS ARE USED, THEY SHALL BE SEPARATED BY AT LEAST 12 INCHES OF COMPACTED AGGREGATE FILL.
5. INLET AND OUTLET PROTECTION IS TO BE INSTALLED AS DETAILED.
6. GEOTEXTILE FABRIC SHALL BE PLACED ATOP THE EXISTING GRADE PRIOR TO PLACEMENT OF THE PIPE AND AGGREGATE. THE FABRIC SHALL EXTEND A MINIMUM SIX INCHES AND A MAXIMUM ONE-FOOT BEYOND THE END OF THE CULVERT AND BEDDING MATERIAL.



VERMONT ELECTRIC POWER COMPANY, INC.  
366 PINNACLE RIDGE ROAD  
RUTLAND, VERMONT 05701

## WETLAND CROSS-CULVERT DETAIL

DATE: 08/2023

REV:

REF:

CRS-11

# VELCO ENVIRONMENTAL GUIDANCE MANUAL

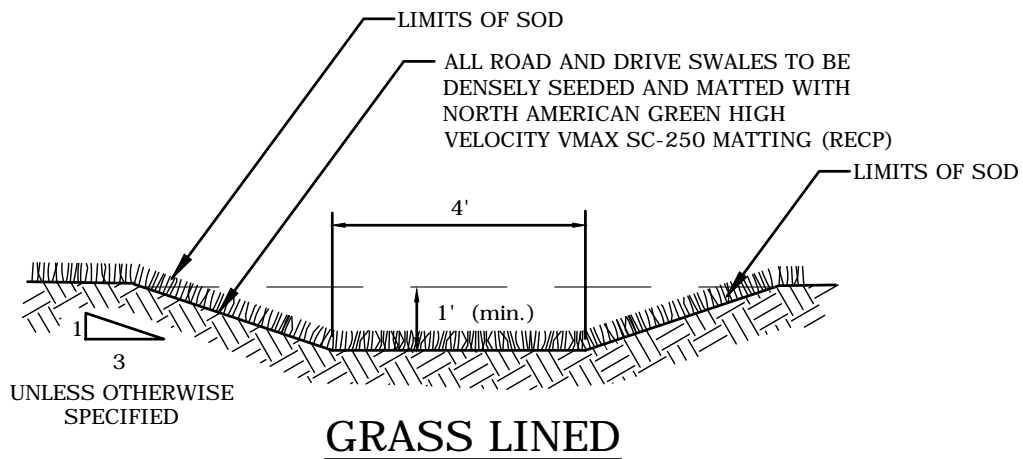
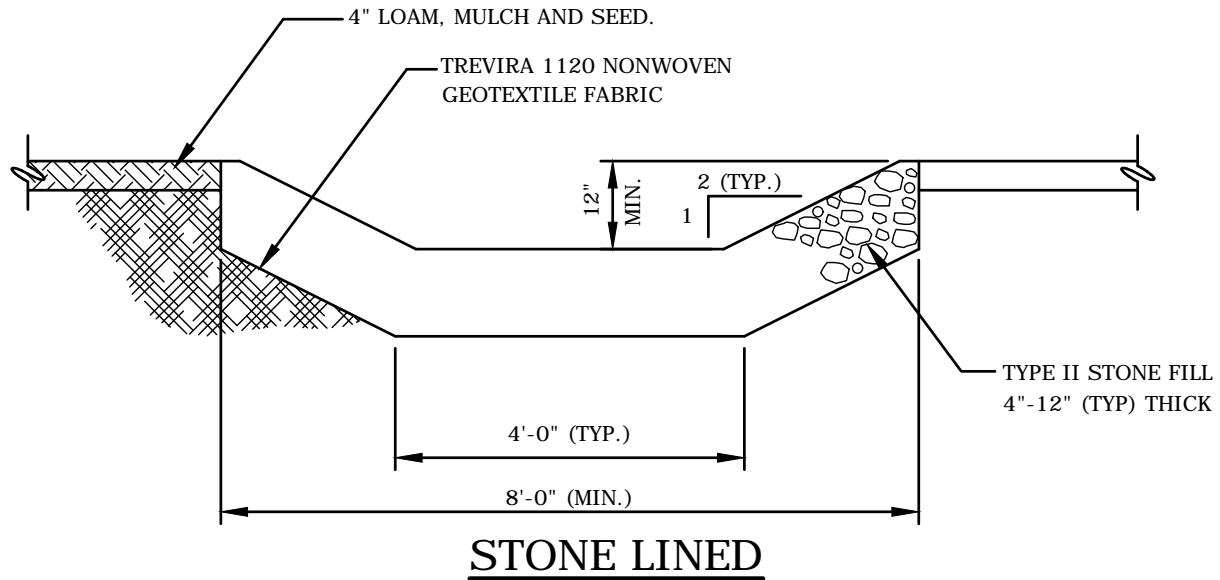

**SWALE NOTES:**

1. SWALES SHALL BE CONSTRUCTED AT THE BEGINNING OF THE PROJECT, IMMEDIATELY AFTER STRIPPING OF THE SITE.
2. LINE SWALE WITH SOD OR 4" OF TOPSOIL AND JUTE NETTING, ADEQUATELY PINNED IN PLACE TO PREVENT MOVEMENT.
3. REPLACE OR REPAIR SOD AS NEEDED DURING THE CONSTRUCTION PERIOD.



VERMONT ELECTRIC POWER COMPANY, INC.  
366 PINNACLE RIDGE ROAD  
RUTLAND, VERMONT 05701

TREATMENT SWALE  
DETAIL

DATE: 08/2023

REV:

REF:

SW-1

# VELCO ENVIRONMENTAL GUIDANCE MANUAL

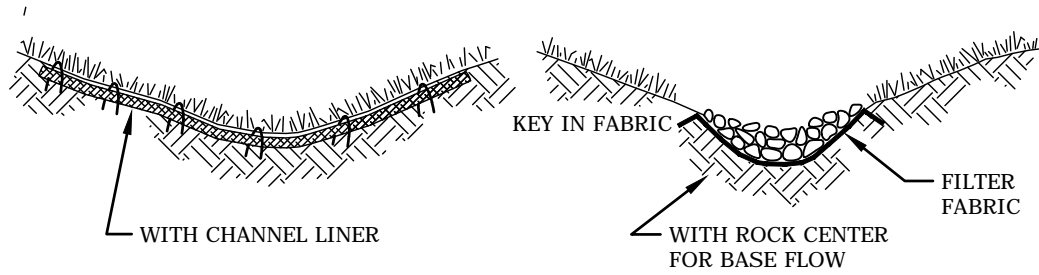

TYPICAL PARABOLIC DITCH  
CROSS-SECTION

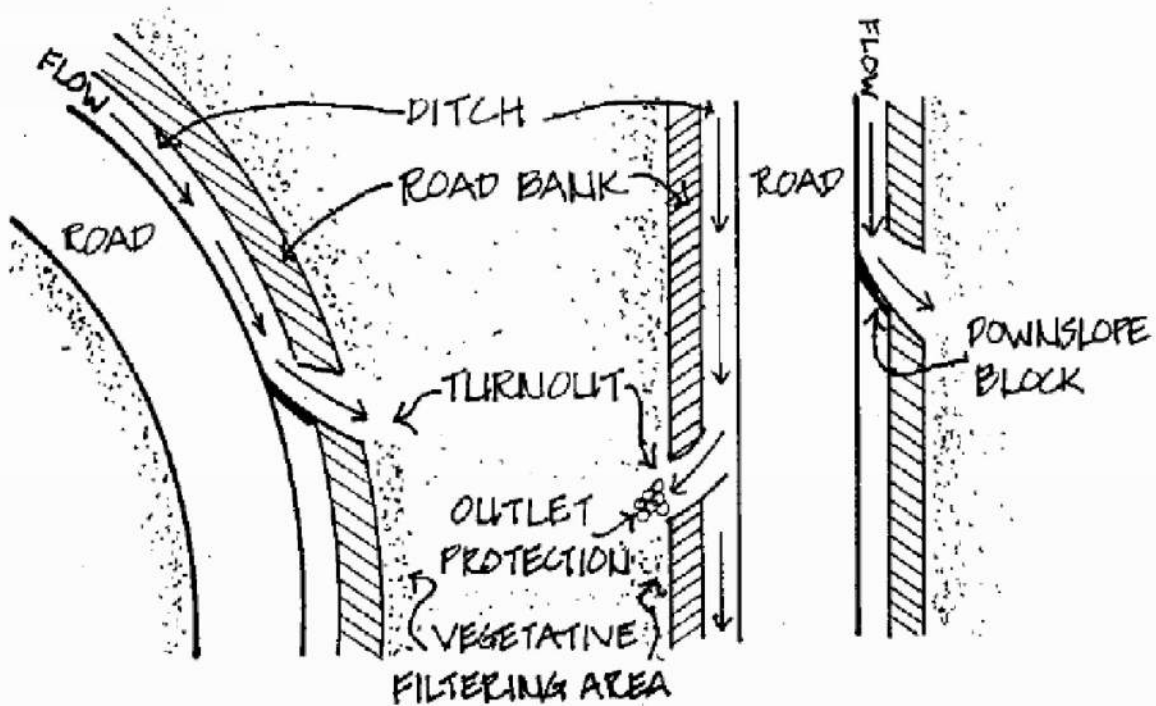

ROAD GRADE SPACING BETWEEN TURNOUTS

1-2%	200 FEET
3-10%	150 FEET
+10%	100 FEET

1. TURNOUTS WITH LESS THAN A 5% SLOPE WILL BE SEEDED WITH A CONSERVATION MIX AND MULCHED WITH HAY OR AN EROSION CONTROL BLANKET.
2. ON STEEPER SLOPES, SECURE NON-WOVEN GEOTEXTILE FABRIC ON THE SOIL AND COVER WITH 3" - 6" STONE RIP-RAP.
3. TURNOUTS SHALL NOT BE INSTALLED TO DRAIN DIRECTLY INTO AN IDENTIFIED WATER RESOURCE.
4. SPECIFIC LOCATIONS WILL BE DETERMINED IN THE FIELD BY THE PROJECT ENVIRONMENTAL INSPECTOR(S), OPSC, AND APPROPRIATE CONSTRUCTION PERSONNEL.



VERMONT ELECTRIC POWER COMPANY, INC.  
366 PINNACLE RIDGE ROAD  
RUTLAND, VERMONT 05701

## DITCH TURN-OUT DETAIL

DATE: 08/2023

REV:

REF:

SW-2

# VELCO ENVIRONMENTAL GUIDANCE MANUAL

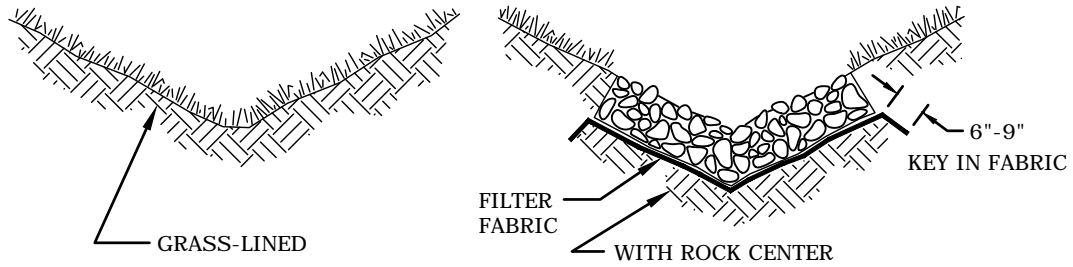

TYPICAL V-SHAPED CHANNEL  
CROSS-SECTION

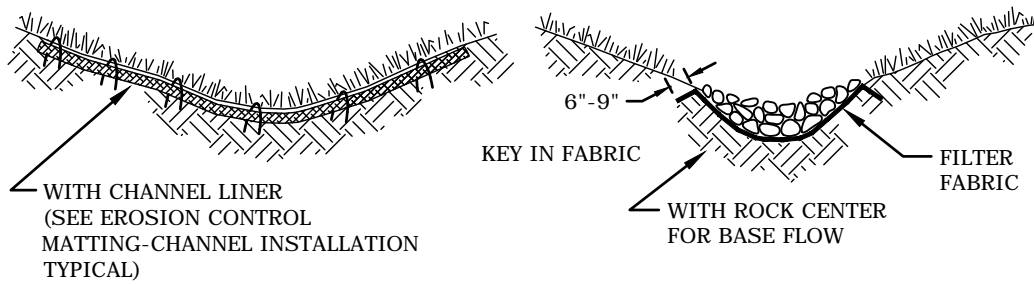

TYPICAL PARABOLIC CHANNEL  
CROSS-SECTION

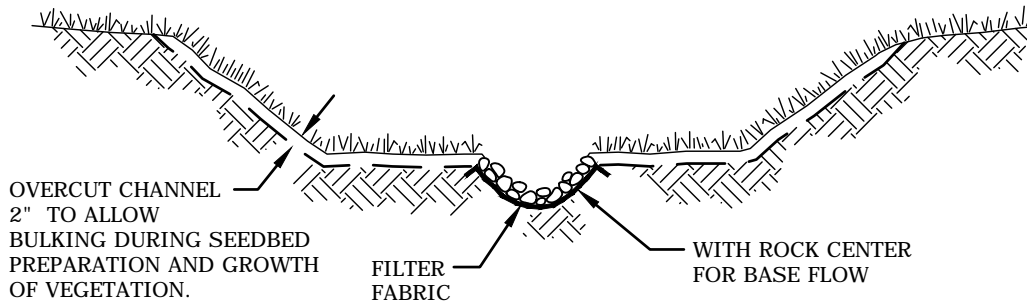

TYPICAL TRAPEZOIDAL CHANNEL  
CROSS-SECTION



VERMONT ELECTRIC POWER COMPANY, INC.  
366 PINNACLE RIDGE ROAD  
RUTLAND, VERMONT 05701

WATER DIVERSION CHANNEL

DETAIL

DATE: 08/2023

REV:

REF:

SW-3

# VELCO ENVIRONMENTAL GUIDANCE MANUAL

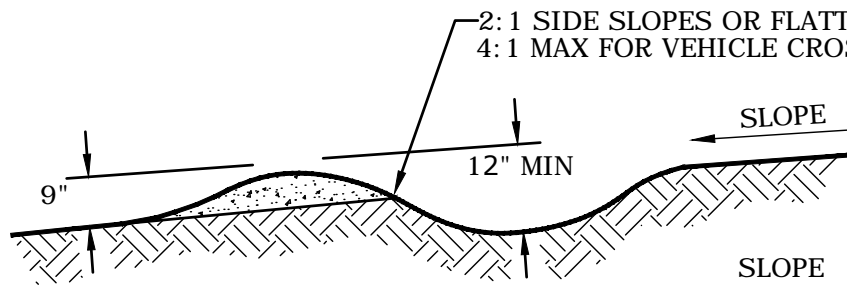
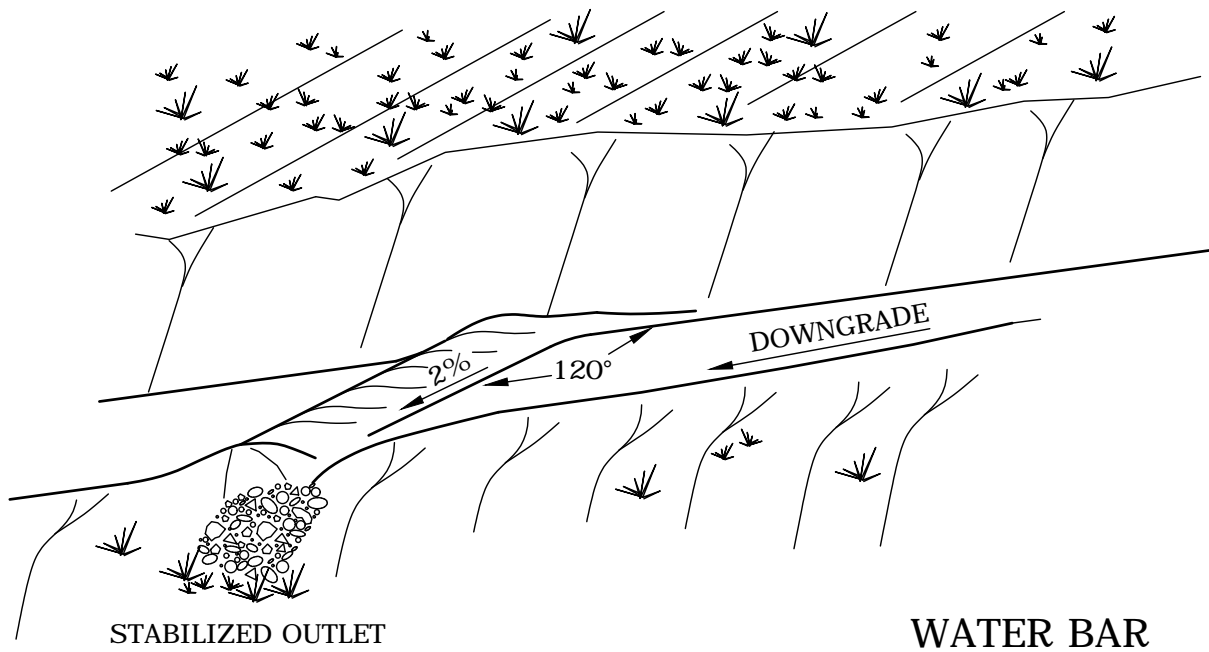

## SECTION

SLOPE	SPACING
< 5	125
5 - 10	100
10 - 20	75
20 - 35	50
> 35	25

## CONSTRUCTION NOTES:

1. INSTALL THE WATER BAR AS NEEDED.
2. TRACK THE RIDGE OF THE WATER BAR TO COMPACT IT TO THE DESIGN CROSS SECTION.
3. THE OUTLET SHALL BE LOCATED ON AN UNDISTURBED AREA. FIELD SPACING WILL BE ADJUSTED TO USE THE MOST STABLE OUTLET AREAS. OUTLET PROTECTION WILL BE PROVIDED WHEN NATURAL CONDITIONS ARE NOT ADEQUATE.
4. INSPECT WATER BARS FOR EROSION DAMAGE AND SEDIMENT. CHECK OUTLET AREAS AND MAKE REPAIRS AS NEEDED TO RESTORE PROPER OPERATION.
5. VEHICLES CROSSING SHALL BE STABILIZED WITH GRAVEL, AS NEEDED.



VERMONT ELECTRIC POWER COMPANY, INC.  
366 PINNACLE RIDGE ROAD  
RUTLAND, VERMONT 05701

## WATER BAR DETAIL

DATE: 08/2023

REV:

REF:

SW-4



# VELCO ENVIRONMENTAL GUIDANCE MANUAL

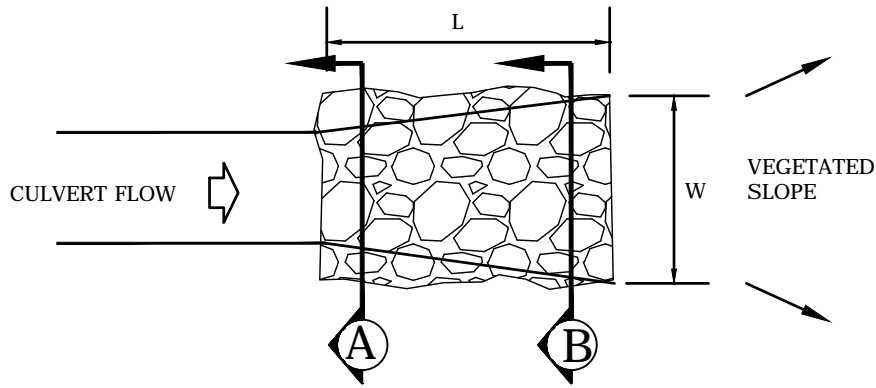

PLAN

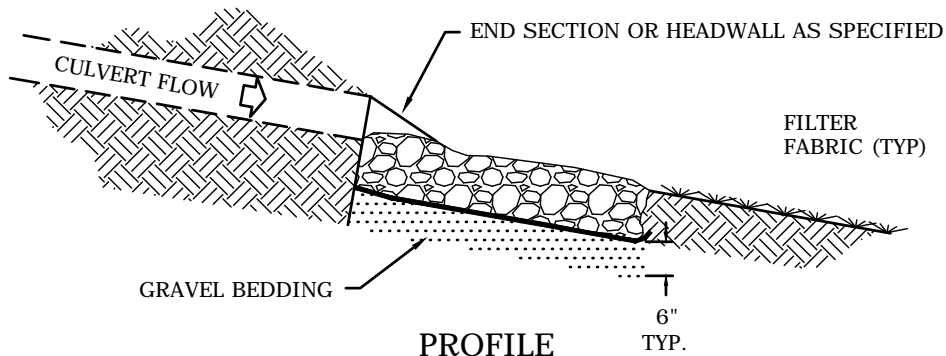

PROFILE

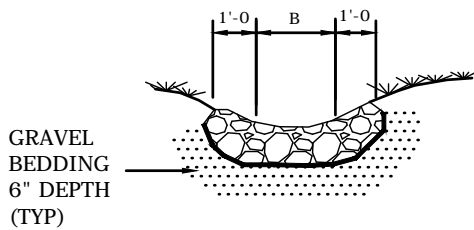

CROSS SECTION

(A)

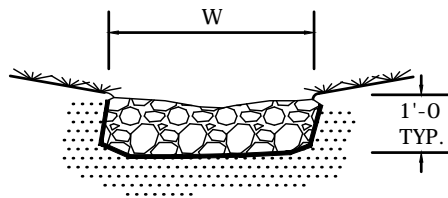

CROSS SECTION

(B)

PIPE (W)	B (Ft.)	W (Ft.)	L (Ft.)	STONE TYPE
15"	2'	4'	8'	I
18"	2'	4'	8'	I
24"	4'	6'	12'	II
30"	4'	6'	14'	II
36"	4'	6'	16'	II
42"	6'	8'	18'	II
48"	6'	8'	20'	II

(USE THESE DIMENSIONS UNLESS OTHERWISE NOTED ON PLAN)



VERMONT ELECTRIC POWER COMPANY, INC.  
366 PINNACLE RIDGE ROAD  
RUTLAND, VERMONT 05701

## STONE DISCHARGE APRON

### DETAIL

DATE: 08/2023

REV:

REF:

SW-5

# VELCO ENVIRONMENTAL GUIDANCE MANUAL

## SURFACING TYPICAL

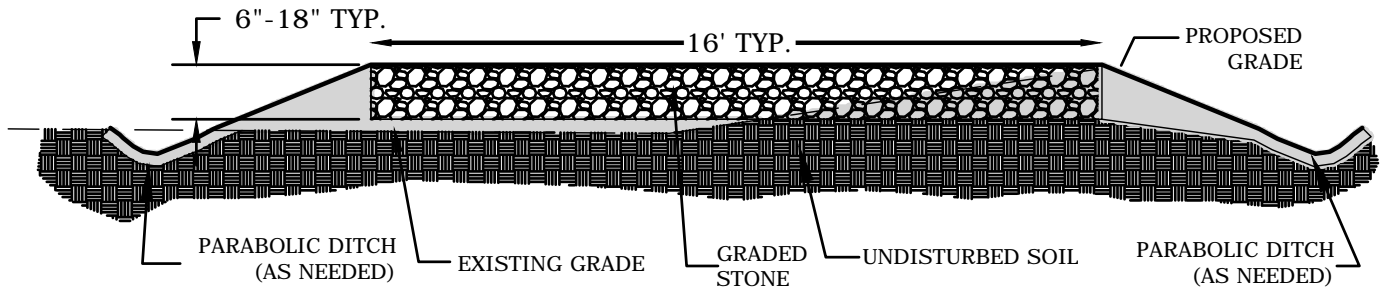

## PROFILE TYPICAL

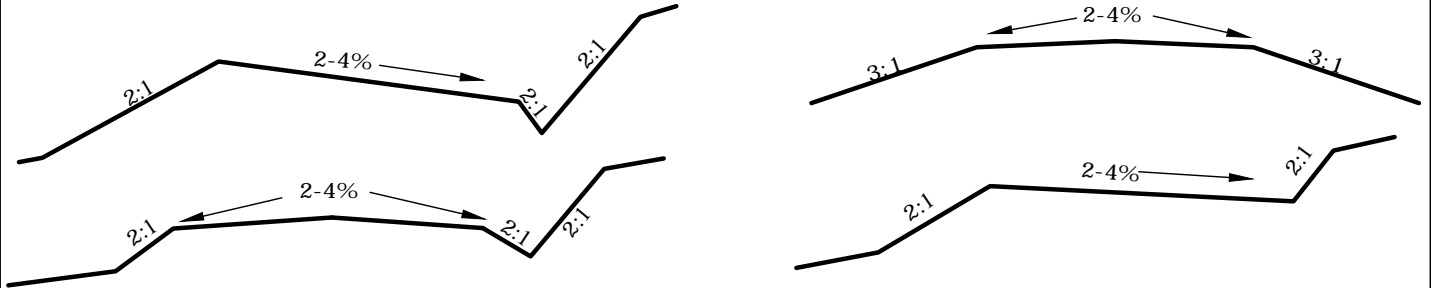

## SURFACING SPECIFICATIONS

CONDITIONS:	ROAD THICKNESS	STONE SIZE	<b>CONSTRUCTION NOTES:</b> A. CONSTRUCTION OPERATIONS SHALL BE CARRIED OUT IN SUCH A MANNER AS TO MINIMIZE POTENTIAL EROSION AND WATER QUALITY DEGRADATION. B. FIXED EROSION CONTROLS AND SITE STABILIZATION SHALL BE CONDUCTED IN ACCORDANCE WITH APPROVED BMPS, OR PURSUANT TO PROJECT SPECIFIC PERMITS. C. TREES, STUMPS, ROOTS, BRUSH, AND WEEDS SHALL BE REMOVED FROM THE WORK AREA IF DETERMINED NECESSARY TO SAFELY CONSTRUCT ROADWAY. D. ON WEAK BEARING SOIL SUCH AS LOOSE ALLUVIAL OR WETLANDS SOILS, SURFACE TREATMENTS SHOULD BE UNDERLAIN WITH WOVEN GEOTEXTILES. E. AT MINIMUM, ROADSIDE DITCHES SHALL BE 1-FT BELOW ROAD SURFACE. F. DISCHARGE POINTS FOR DITCHES SHOULD BE SITED AT THE DIRECTION OF THE ENVIRONMENTAL INSPECTOR AND SHOULD NOT BE NEAR WETLANDS OR STREAMS.
BASE LAYER (NOT EXCESSIVELY WET)	6" TYPICAL USE NECESSARY UNDERLAYMENT*	SEE MATERIAL SPECIFICATION BELOW	
BASE LAYER (WET/POOR SOIL CONDITIONS)	18" TYPICAL USE NECESSARY UNDERLAYMENT*	SEE MATERIAL SPECIFICATION BELOW	

\* AT DISCRETION OF VELCO.

## MATERIAL SPECIFICATIONS

704.06 DENSE GRADED CRUSHED STONE FOR SUBBASE		
SIEVE DESIGNATION	PERCENTAGE BY MASS (WEIGHT) PASSING SQUARE MESH SIEVES	DENSE GRADED CRUSHED STONE FOR SUBBASE:
90 mm (3.5")	100	• DENSE GRADED CRUSHED STONE FOR SUBBASE SHALL CONSIST OF CLEAN, HARD, UNIFORMLY GRADED, CRUSHED STONE. IT SHALL BE SUFFICIENTLY FREE FROM DIRT, DELETERIOUS MATERIAL, AND PIECES THAT ARE STRUCTURALLY WEAK AND SHALL MEET THE FOLLOWING REQUIREMENTS: •• SOURCE OF MATERIAL SHALL BE OBTAINED FROM AREAS STRIPPED AND CLEANED OF SOIL AND DEBRIS BEFORE BLASTING. •• MATERIAL COARSER THAN THE 4.75 MM (NO. 4) SIEVE SHALL NOT BE MORE THAN 30% BY MASS (WEIGHT), OF THIN AND/OR ELONGATED PIECES.
75 mm (3.0")	90-100	
50 mm (2.0")	75-100	
25 mm (1.0")	50-80	
12.5 mm (1/2")	30-60	
4.75 mm (No. 4)	15-40	
75 µm (3.5")	0-6	

704.17 AGGREGATE FOR EROSION PREVENTION AND SEDIMENT CONTROL		
SIEVE DESIGNATION	PERCENTAGE BY MASS (WEIGHT) PASSING SQUARE MESH SIEVES	AGGREGATE FOR EROSION PREVENTION AND SEDIMENT CONTROL:
150 mm (6.0")	100	AGGREGATE FOR EROSION PREVENTION AND SEDIMENT CONTROL SHALL CONSIST OF CLEAN, HARD, CRUSHED STONE OR CRUSHED GRAVEL. IT SHALL BE REASONABLY FREE FROM DIRT AND DELETERIOUS MATERIAL. IT SHALL BE UNIFORMLY GRADED AND MEET THE GRADATION REQUIREMENTS OF THE ADJACENT TABLE AS DETERMINED IN ACCORDANCE WITH AASHTO T 27.
100 mm (4.0")	90-100	
75 mm (3.0")	75-100	
50 mm (2.0")	50-80	

**SOURCES:**

- **SURFACING TYPICAL AND SURFACING SPECS:** DERIVED FROM USDA NRCS DRAWING "ACCESS ROAD; ME-ENG-AR1"
- **PROFILE TYPICAL:** DERIVED FROM USDA FOREST SERVICE PUBLICATION "FOREST ROAD CONSTRUCTION AND MAINTENANCE"
- **MATERIAL SPECS:** DERIVED FROM VTRANS 704.06 AND 704.17



VERMONT ELECTRIC POWER COMPANY, INC.  
366 PINNACLE RIDGE ROAD  
RUTLAND, VERMONT 05701

## ACCESS ROAD DETAIL

DATE: 07/2023

REV: 08/2023

REF:

AR-1

# VELCO ENVIRONMENTAL GUIDANCE MANUAL

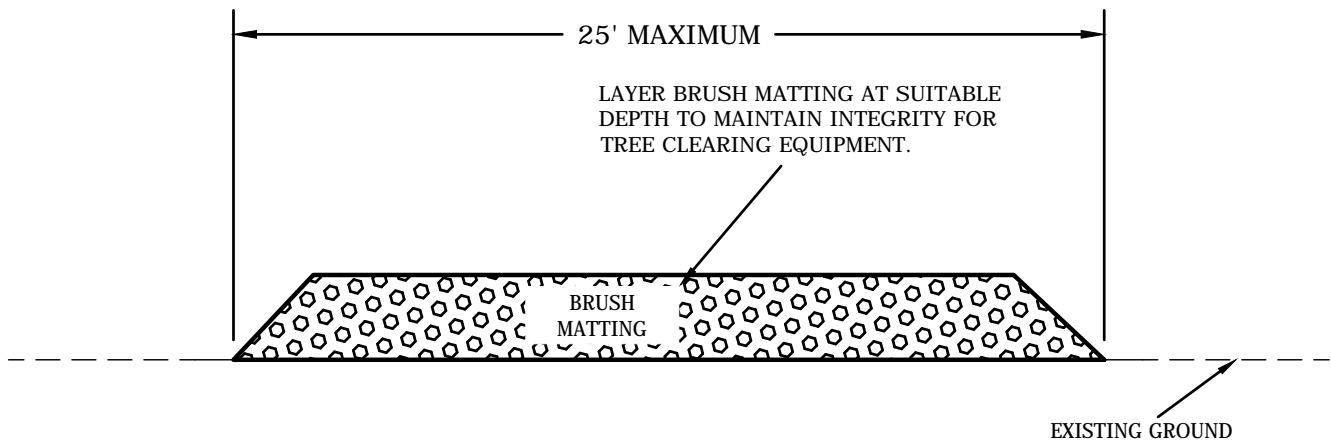

**NOTES:**

1. LAYER BRUSH MATTING AT SUITABLE DEPTH TO MAINTAIN INTEGRITY FOR STABLE EQUIPMENT TRAVEL.
2. REMOVE ALL BRUSH MATTING FROM WETLANDS UPON COMPLETION OF WORK.
3. BRUSH MATTING IS NOT TO BE UTILIZED IN OPEN WATER WETLANDS OR STREAMS UNLESS THEY HAVE MINIMAL FLOW AND ARE GENERALLY LESS THAN 6' WIDE.
4. PERFORM ROUTINE INSPECTIONS FOR INTEGRITY AND TO ENSURE ADEQUATE WETLAND PROTECTION.



VERMONT ELECTRIC POWER COMPANY, INC.  
 366 PINNACLE RIDGE ROAD  
 RUTLAND, VERMONT 05701

## TEMPORARY BRUSH MATTING DETAIL

DATE: 08/2023

REV:

REF:

AR-2

# VELCO ENVIRONMENTAL GUIDANCE MANUAL

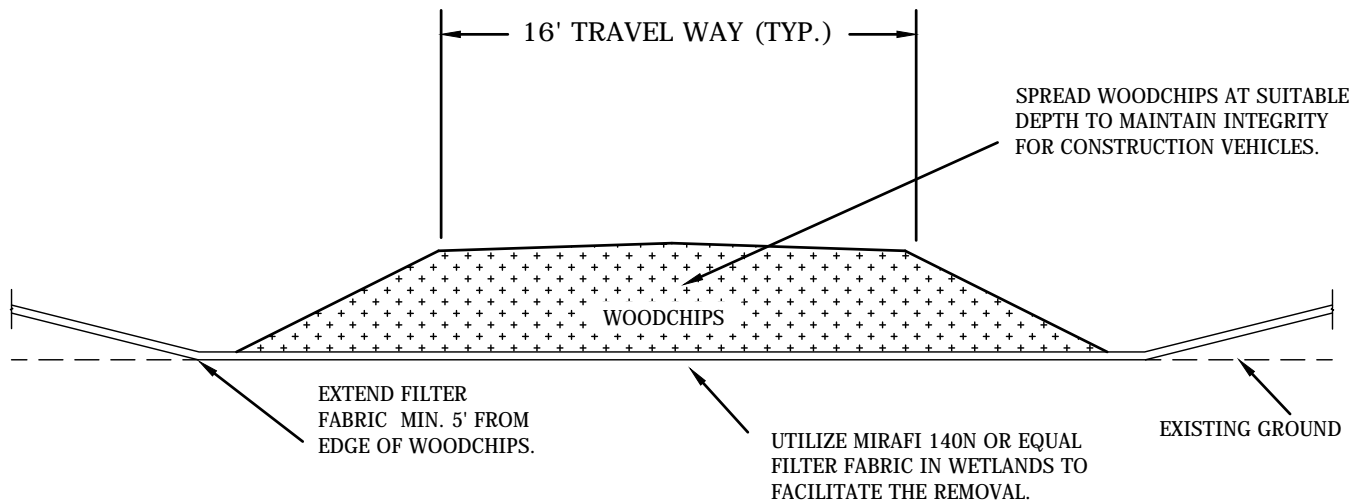

**NOTES:**

1. SPREAD WOODCHIPS AT A SUITABLE DEPTH TO MAINTAIN INTEGRITY FOR CONSTRUCTION EQUIPMENT.
2. FOR TEMPORARY WOOD CHIP ROADS IN WETLANDS, FILTER FABRIC MAY BE PLACED ON EXISTING GRADE TO INCREASE INTEGRITY OF GROUND SURFACE AND FACILITATE RESTORATION.
3. WOODCHIPS ARE NOT TO BE UTILIZED IN OPEN WATER WETLANDS OR STREAMS.
4. UPON COMPLETION OF WORK, WOODCHIP ROADS ARE TO BE REMOVED FROM WETLANDS AND/OR BROADCAST IN A THIN LAYER.
5. PERFORM ROUTINE INSPECTIONS FOR INTEGRITY AND TO ENSURE ADEQUATE WETLAND PROTECTION.



VERMONT ELECTRIC POWER COMPANY, INC.  
 366 PINNACLE RIDGE ROAD  
 RUTLAND, VERMONT 05701

## TEMPORARY WOODCHIP ROAD DETAIL

DATE: 08/2023

REV:

REF:

AR-3

# VELCO ENVIRONMENTAL GUIDANCE MANUAL

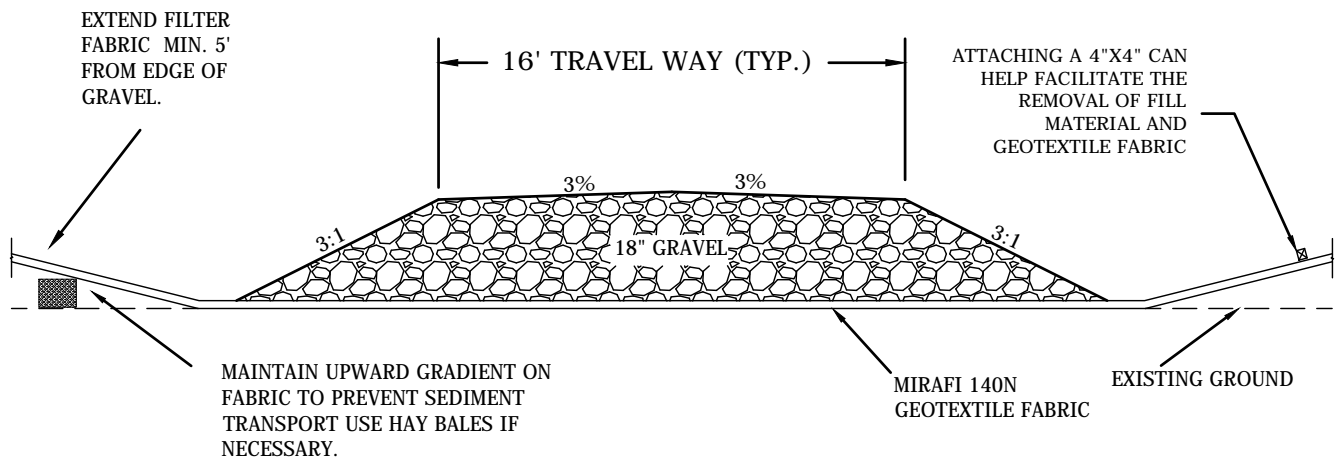

## NOTES:

1. TEMPORARY ROAD MATERIALS SHALL BE INSTALLED ATOP EXISTING GROUND SURFACE WITHOUT GRADING.
2. GEOTEXTILE FABRIC SHALL BE UTILIZED AS A BARRIER BETWEEN EXISTING GROUND SURFACE AND FILL MATERIAL. A 4"X4" TIMBER CAN BE ATTACHED TO THE EDGE OF THE GEOTEXTILE FABRIC TO FACILITATE REMOVAL.
3. ONCE WORK IS COMPLETE, FILL MATERIAL AND GEOTEXTILE FABRIC SHOULD BE REMOVED STARTING FROM THE FARTHEST POINT, WORKING OUT OF THE SITE.
4. REMOVAL OF MATERIAL SHOULD BE DONE IN A FASHION AS TO MINIMIZE ANY IMPACTS TO THE UNDERLYING GROUND SURFACE.
5. APPLY SEED AND MULCH AS NECESSARY TO ANY DISTURBED AREAS.



VERMONT ELECTRIC POWER COMPANY, INC.  
366 PINNACLE RIDGE ROAD  
RUTLAND, VERMONT 05701

## TEMPORARY ACCESS ROAD DETAIL

DATE: 08/2023

REV:

REF:

AR-4